

2023 KFX®90 PARTS DIAGRAM

Cylinder Head

E1111

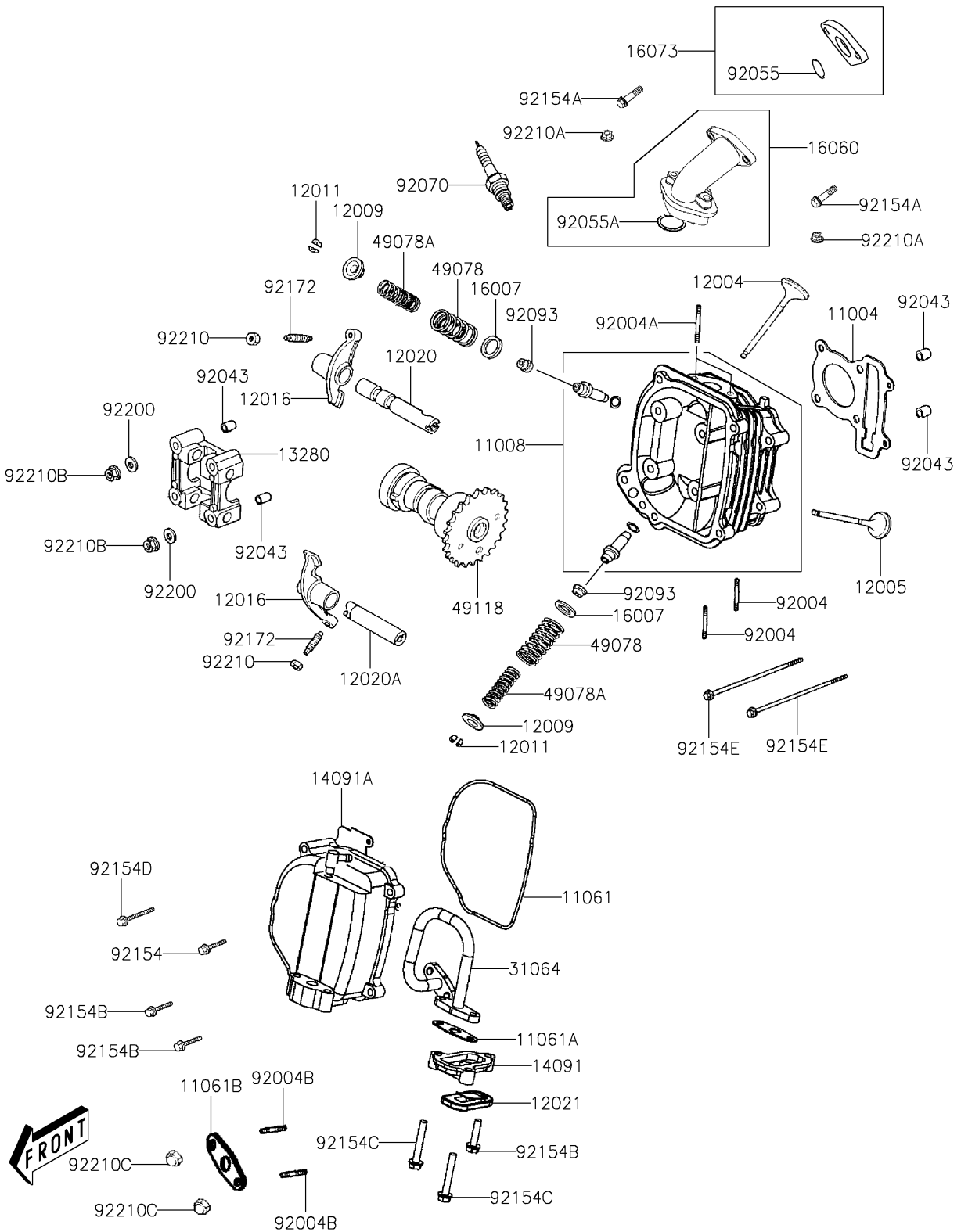

2023 KFX® 90 PARTS LIST

Cylinder Head

ITEM NAME	PART NUMBER	QUANTITY
GASKET-HEAD (Ref # 11004)	11004-Y002	1
HEAD-COMP-CYLINDER (Ref # 11008)	11008-Y004	1
GASKET,CYLINDER HEAD COVER (Ref # 11061)	11061-Y010	1
GASKET (Ref # 11061A)	11061-Y018	1
GASKET (Ref # 11061B)	11061-Y020	1
VALVE-INTAKE (Ref # 12004)	12004-Y002	1
VALVE-EXHAUST (Ref # 12005)	12005-Y002	1
RETAINER-VALVE SPRING (Ref # 12009)	12009-Y001	2
COLLET (Ref # 12011)	12011-Y001	4
ARM-ROCKER (Ref # 12016)	12016-Y001	2
SHAFT-ROCKER,IN (Ref # 12020)	12020-Y001	1
SHAFT-ROCKER,EX (Ref # 12020A)	12020-Y003	1
VALVE-ASSY-REED (Ref # 12021)	12021-Y002	1
HOLDER,CAMSHAFT (Ref # 13280)	13280-Y002	1
COVER,REED VALVE (Ref # 14091)	14091-Y015	1
COVER,CYLINDER HEAD (Ref # 14091A)	14091-Y016	1
SEAT-SPRING (Ref # 16007)	16007-Y001	2
PIPE-INTAKE (Ref # 16060)	16060-Y004	1
INSULATOR (Ref # 16073)	16073-Y002	1
PIPE-COMP (Ref # 31064)	31064-Y003	1
SPRING-ENGINE VALVE,OUTER (Ref # 49078)	49078-Y002	2
SPRING-ENGINE VALVE,INNER (Ref # 49078A)	49078-Y003	2
CAMSHAFT-COMP (Ref # 49118)	49118-Y002	1
STUD,8X32 (Ref # 92004)	92004-Y006	2
STUD,6X50 (Ref # 92004A)	92004-Y007	2
STUD,6X28 (Ref # 92004B)	92004-Y011	2
PIN,10X16 (Ref # 92043)	92043-Y013	4
RING-O,23X2.4 (Ref # 92055)	92055-Y007	1
RING-O,22X2.0 (Ref # 92055A)	92055-Y008	1

2023 KFX® 90 PARTS LIST

Cylinder Head

ITEM NAME	PART NUMBER	QUANTITY
PLUG-SPARK,CR7HSA (Ref # 92070)	92070-Y002	1
SEAL (Ref # 92093)	92093-Y025	2
BOLT,FLANGE,6X35 (Ref # 92154)	92154-Y020	1
BOLT,FLANGE,6X25 (Ref # 92154A)	92154-Y066	2
BOLT,FLANGE,6X25 (Ref # 92154B)	92154-Y130	3
BOLT,FLANGE,6X40 (Ref # 92154C)	92154-Y131	2
BOLT,FLANGE,6X50 (Ref # 92154D)	92154-Y142	1
BOLT,FLANGE,6X95 (Ref # 92154E)	92154-Y143	2
SCREW (Ref # 92172)	92172-Y003	2
WASHER,8MM (Ref # 92200)	92200-Y009	4
NUT (Ref # 92210)	92210-Y004	2
NUT,6MM (Ref # 92210A)	92210-Y027	2
NUT,8MM (Ref # 92210B)	92210-Y028	4
NUT,6MM (Ref # 92210C)	92210-Y035	2