

2022 VERSYS® 650 PARTS DIAGRAM

Engine Mount

F2122

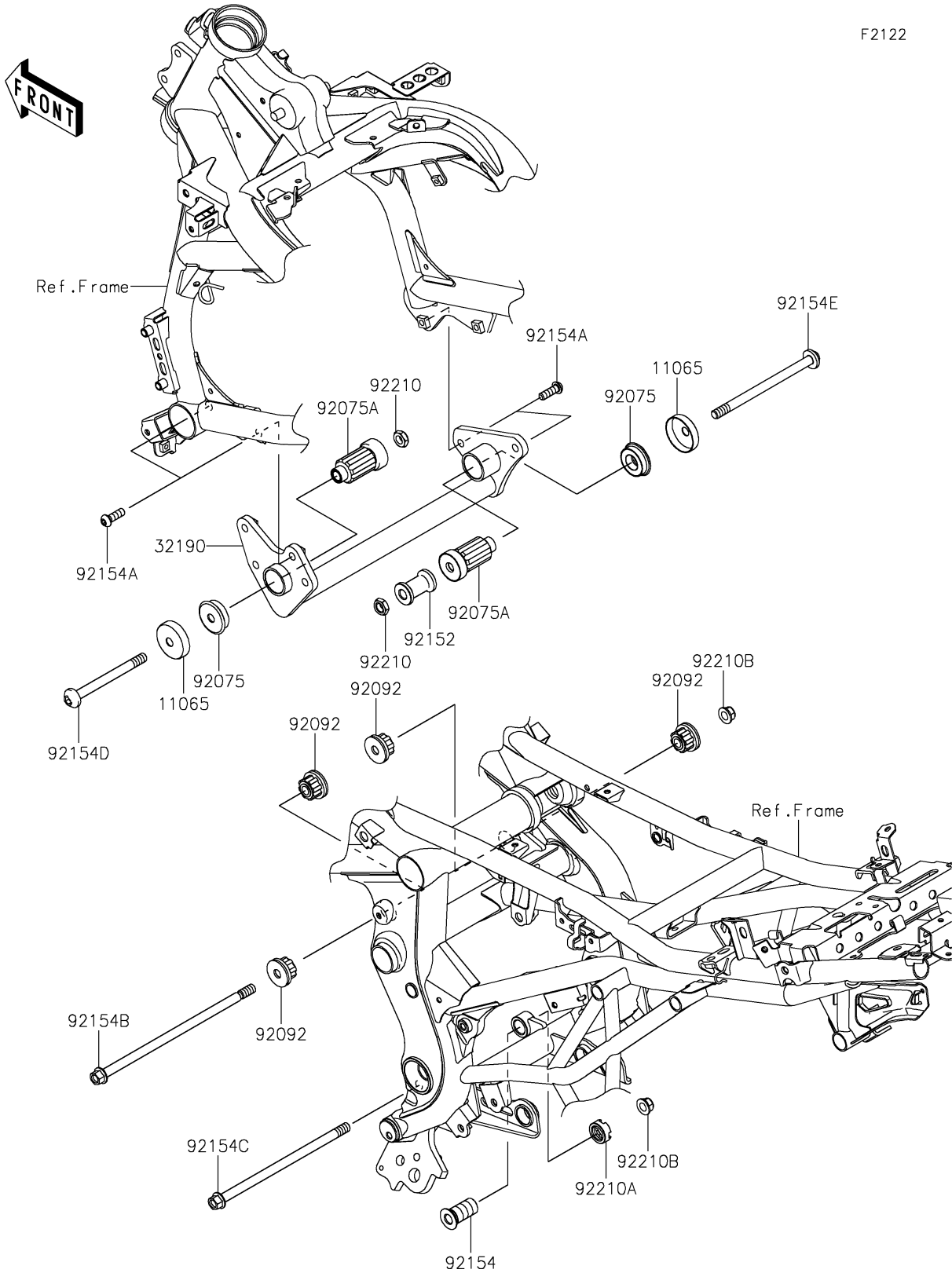

2022 VERSYS® 650 PARTS LIST

Engine Mount

ITEM NAME	PART NUMBER	QUANTITY
CAP,10.5X43X10 (Ref # 11065)	11065-0871	2
BRACKET-ENGINE,FR (Ref # 32190)	32190-0871	1
DAMPER,ENGINE MOUNT (Ref # 92075)	92075-1738	2
DAMPER,ENGINE MOUNT,MAIN (Ref # 92075A)	92075-1739	2
BUSHING-RUBBER (Ref # 92092)	92092-0021	4
COLLAR,10.5X26X40 (Ref # 92152)	92152-1878	1
BOLT,ENGINE MOUNT,18MM (Ref # 92154)	92154-0249	1
BOLT,SOCKET,8X25 (Ref # 92154A)	92154-1485	4
BOLT,FLANGED,10X237 (Ref # 92154B)	92154-1505	1
BOLT,FLANGED,10X200 (Ref # 92154C)	92154-1660	1
BOLT,SOCKET,10X110 (Ref # 92154D)	92154-1671	1
BOLT,SOCKET,10X150 (Ref # 92154E)	92154-1672	1
NUT,LOCK,10MM (Ref # 92210)	92210-0784	2
NUT,CASTLE,18MM (Ref # 92210A)	92210-0963	1
NUT,LOCK,FLANGED,10MM (Ref # 92210B)	92210-1081	2