

2021 NINJA® 400 ABS

PARTS DIAGRAM

Stand(s)

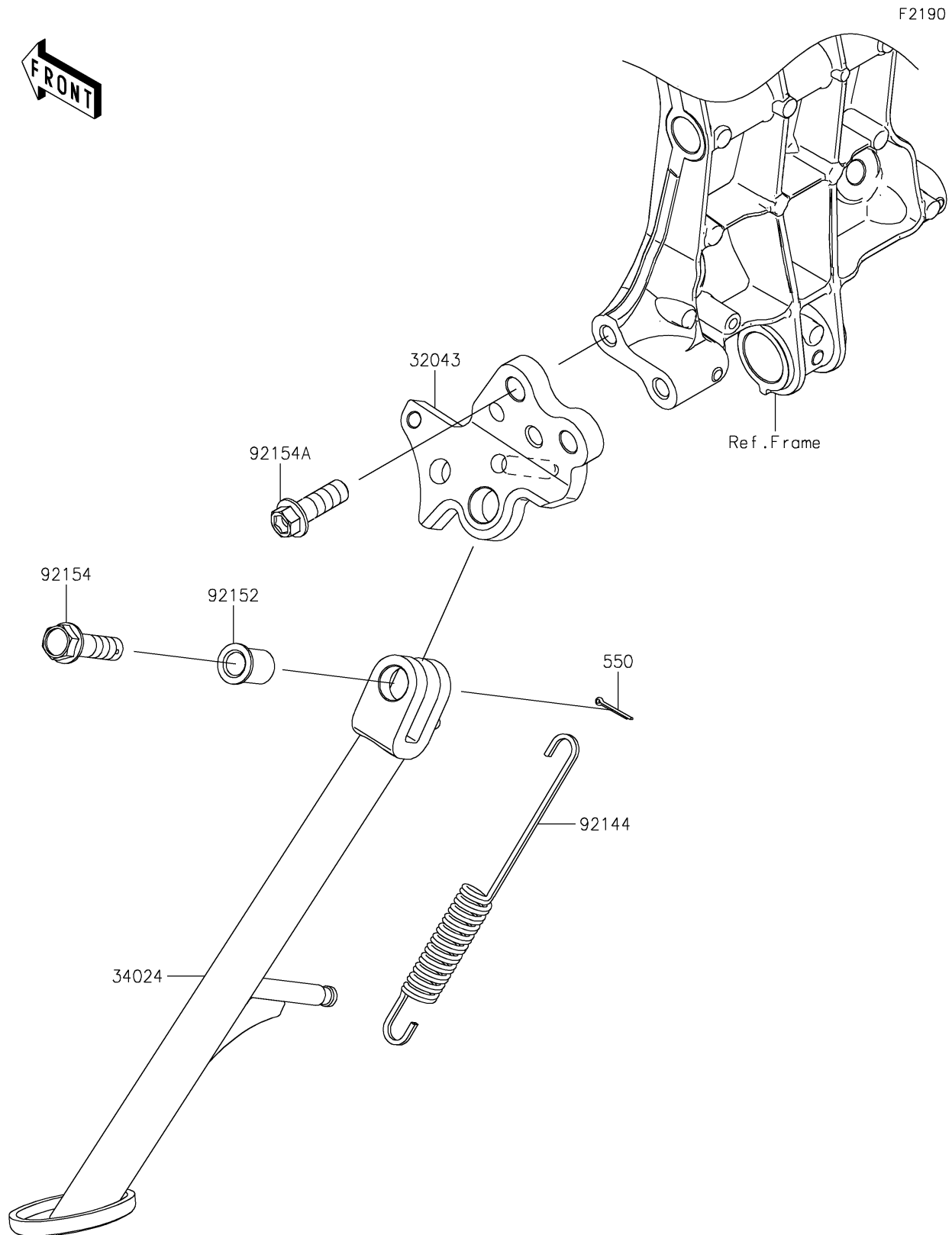

2021 NINJA® 400 ABS

PARTS LIST

Stand(s)

ITEM NAME	PART NUMBER	QUANTITY
BRACKET-STAND (Ref # 32043)	32043-0624	1
STAND-SIDE (Ref # 34024)	34024-0149	1
SPRING,SIDE STAND (Ref # 92144)	92144-1818	1
COLLAR,10.2X15X20.1 (Ref # 92152)	92152-1914	1
BOLT,FLANGED,10X37 (Ref # 92154)	92154-1539	1
BOLT,10X30,TB2468 (Ref # 92154A)	92154-2814	2
PIN-COTTER,2.0X15 (Ref # 550)	550AA2015	1