

1987 Voyager PARTS DIAGRAM

Accessory

F2910B-0016

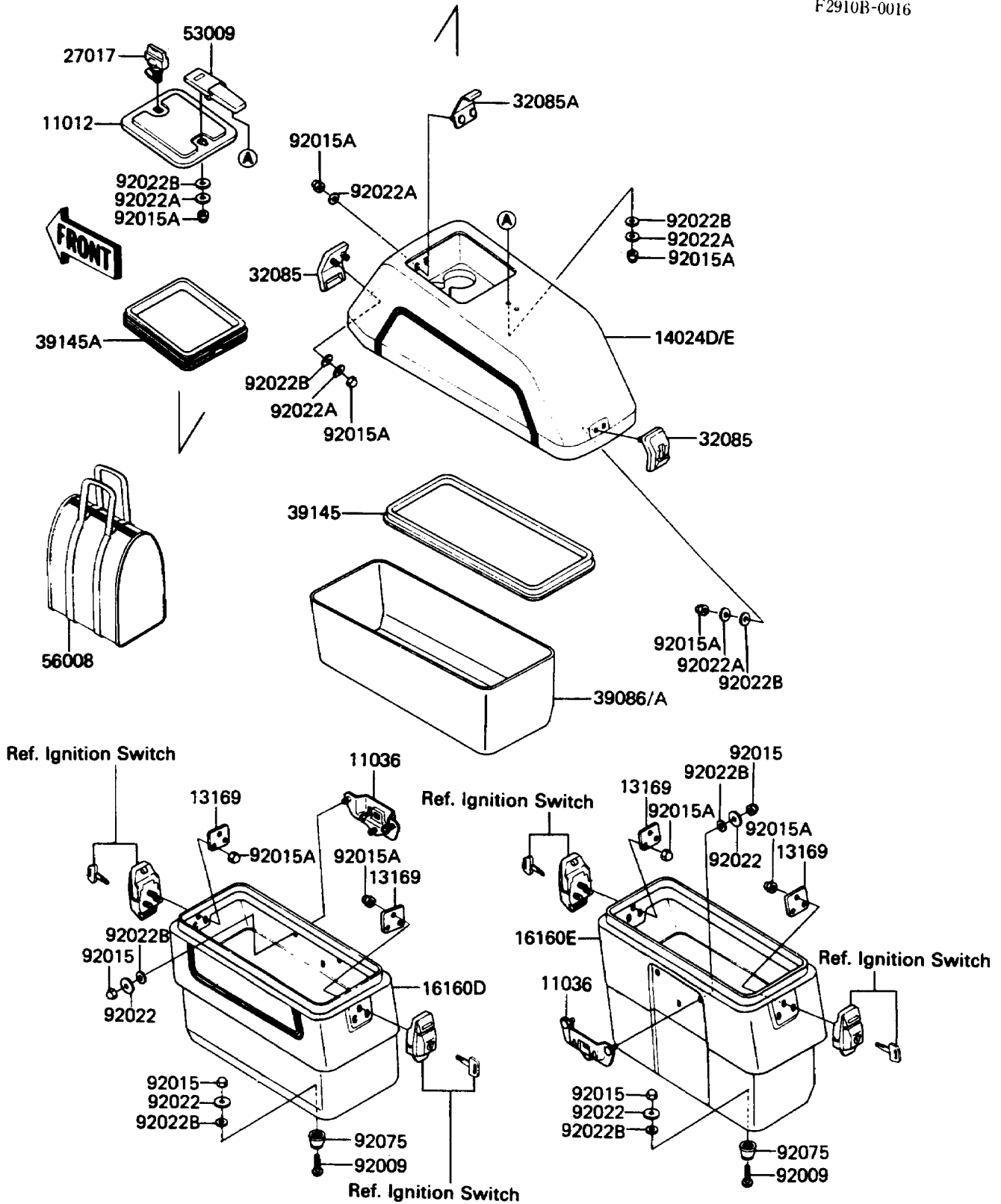

1987 Voyager PARTS LIST

Accessory

ITEM NAME	PART NUMBER	QUANTITY
CAP,SIDEBAG (Ref # 11012)	11012-1295	1
BRACKET-A,SIDEBAG (Ref # 11036)	11036-1912	1
PLATE,SIDEBAG (Ref # 13169)	13169-1600	1
COVER,SIDEBAG,LH,L.V.RED (Ref # 14024D)	14025-5238-P5	1
COVER,SIDEBAG,RH,L.V.RED (Ref # 14024E)	14025-5239-P5	1
BODY,SIDEBAG,LH,L.V.RED (Ref # 16160D)	16160-5011-P5	1
BODY,SIDEBAG,RH,L.V.RED (Ref # 16160E)	16160-5012-P5	1
LOCK,BAG (Ref # 27017)	27017-1103	1
STOPPER,SIDEBAG (Ref # 32085)	32085-1122	1
STOPPER,SIDEBAG COVER (Ref # 32085A)	32085-1154	1
PAD-STORAGE,SIDEBAG,LH (Ref # 39086)	39086-1003	1
PAD-STORAGE,SIDEBAG,RH (Ref # 39086A)	39086-1004	1
TRIM-SEAL,SIDEBAG (Ref # 39145)	39145-1003	1
TRIM-SEAL,SIDEBAG (Ref # 39145A)	39145-1052	1
HINGE,SIDEBAG (Ref # 53009)	53009-1039	1
BAG,SIDE,INNER (Ref # 56008)	56008-1025	1
SCREW,6X28 (Ref # 92009)	92009-1066	1
NUT,LOCK 6MM (Ref # 92015)	92015-1262	1
NUT,LOCK 5MM (Ref # 92015A)	92015-1263	1
WASHER,7X28X1.6,BLACK (Ref # 92022)	92022-1392	1
WASHER,5.5X20X1.2 (Ref # 92022A)	92022-1405	1
WASHER,RUBBER (Ref # 92022B)	92022-1477	1
DAMPER,TRUNK & SIDEBAG (Ref # 92075)	92075-1510	1