

1987 Voyager PARTS DIAGRAM

Accessory

F2910-0037

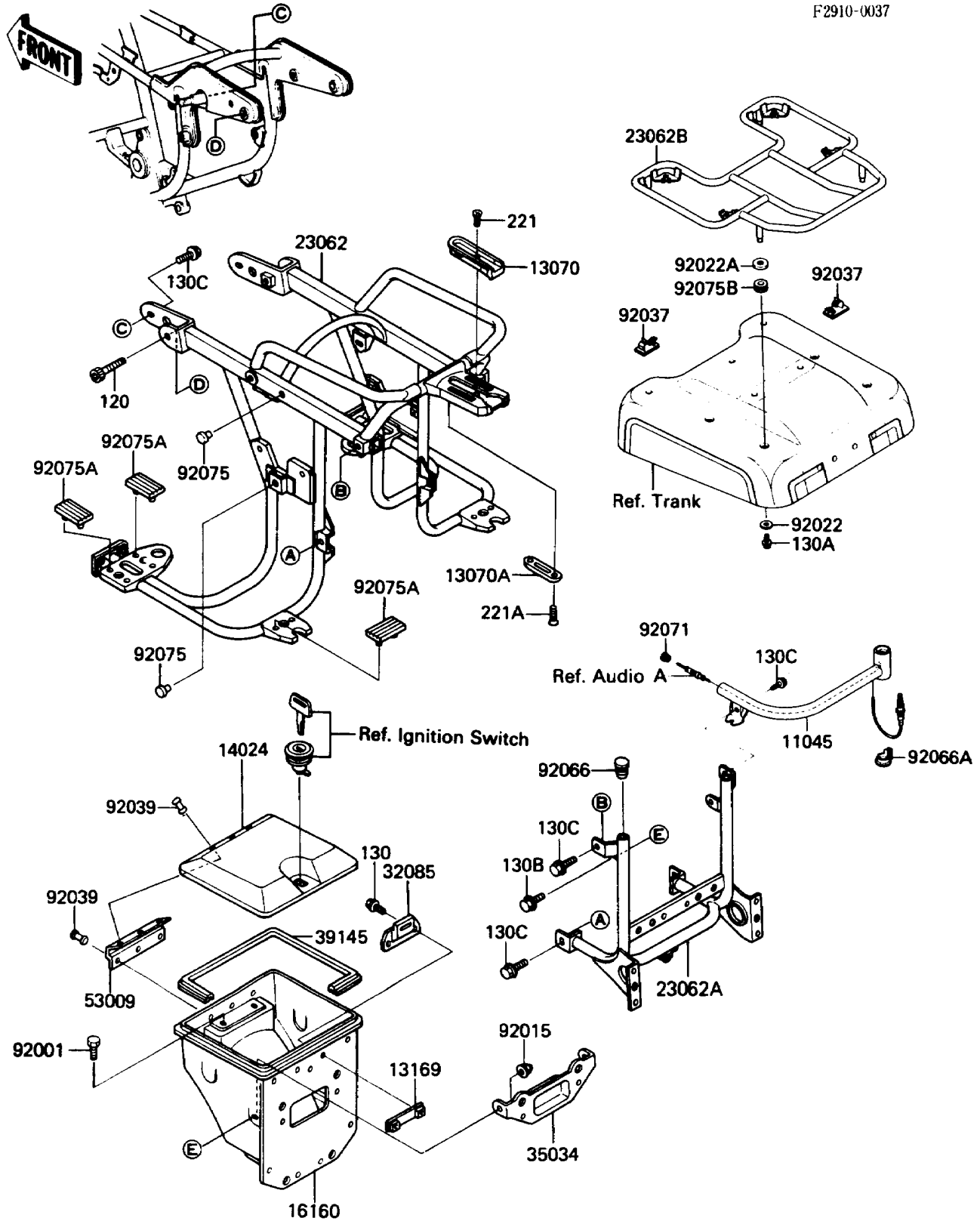

1987 Voyager PARTS LIST

Accessory

ITEM NAME	PART NUMBER	QUANTITY
BRACKET,ANTENNA (Ref # 11045)	11045-1983	1
GUIDE,TRUNK LOCK (Ref # 13070)	13070-1083	1
GUIDE,TRUNK LOCK (Ref # 13070A)	13070-1104	1
PLATE,STORAGE CASE (Ref # 13169)	13169-1611	1
COVER,STORAGE CASE (Ref # 14024)	14025-1673	1
BODY,STORAGE CASE (Ref # 16160)	16160-1012	1
BRACKET-COMP,SIDEBAG (Ref # 23062)	23062-1052	1
BRACKET-COMP,TAIL LAMP (Ref # 23062A)	23062-1053	1
BRACKET-COMP,REAR SPEAKER (Ref # 23062B)	23062-1075	1
STOPPER,STORAGE CASE CAP (Ref # 32085)	32085-1127	1
REINFORCE,REAR FENDER (Ref # 35034)	35034-1106	1
TRIM-SEAL,STORAGE CASE (Ref # 39145)	39145-1008	1
HINGE,STORAGE CASE (Ref # 53009)	53009-1038	1
BOLT,6X20 (Ref # 92001)	92001-1826	1
NUT,CAP,6MM,BLACK (Ref # 92015)	92015-1170	1
WASHER,6.5X26X1,BLACK (Ref # 92022)	92022-1248	1
WASHER,CAP TYPE (Ref # 92022A)	92022-1638	1
CLAMP,HARNESS (Ref # 92037)	92037-1816	1
RIVET,BLIND (Ref # 92039)	92039-1040	1
PLUG (Ref # 92066)	92066-1093	1
PLUG (Ref # 92066A)	92066-1287	1
GROMMET (Ref # 92071)	92071-1156	1
DAMPER (Ref # 92075)	92075-005	1
DAMPER (Ref # 92075A)	92075-1489	1
DAMPER (Ref # 92075B)	92075-197	1
BOLT-SOCKET,8X55 (Ref # 120)	120S0855	1
BOLT-FLANGED,5X12 (Ref # 130)	130C0512	1
BOLT-FLANGED,6X10,BLACK (Ref # 130A)	130C0610	1
BOLT-FLANGED,6X12 (Ref # 130B)	130C0612	1

1987 Voyager PARTS LIST

Accessory

ITEM NAME	PART NUMBER	QUANTITY
BOLT-FLANGED,8X16,BLACK (Ref # 130C)	130J0816	1
SCREW-CSK-CROS,5X8 (Ref # 221)	221C0508	1
SCREW-CSK-CROS (Ref # 221A)	221C0512	1