

1988 Voyager PARTS DIAGRAM

Ignition Switch/Locks/Reflectors

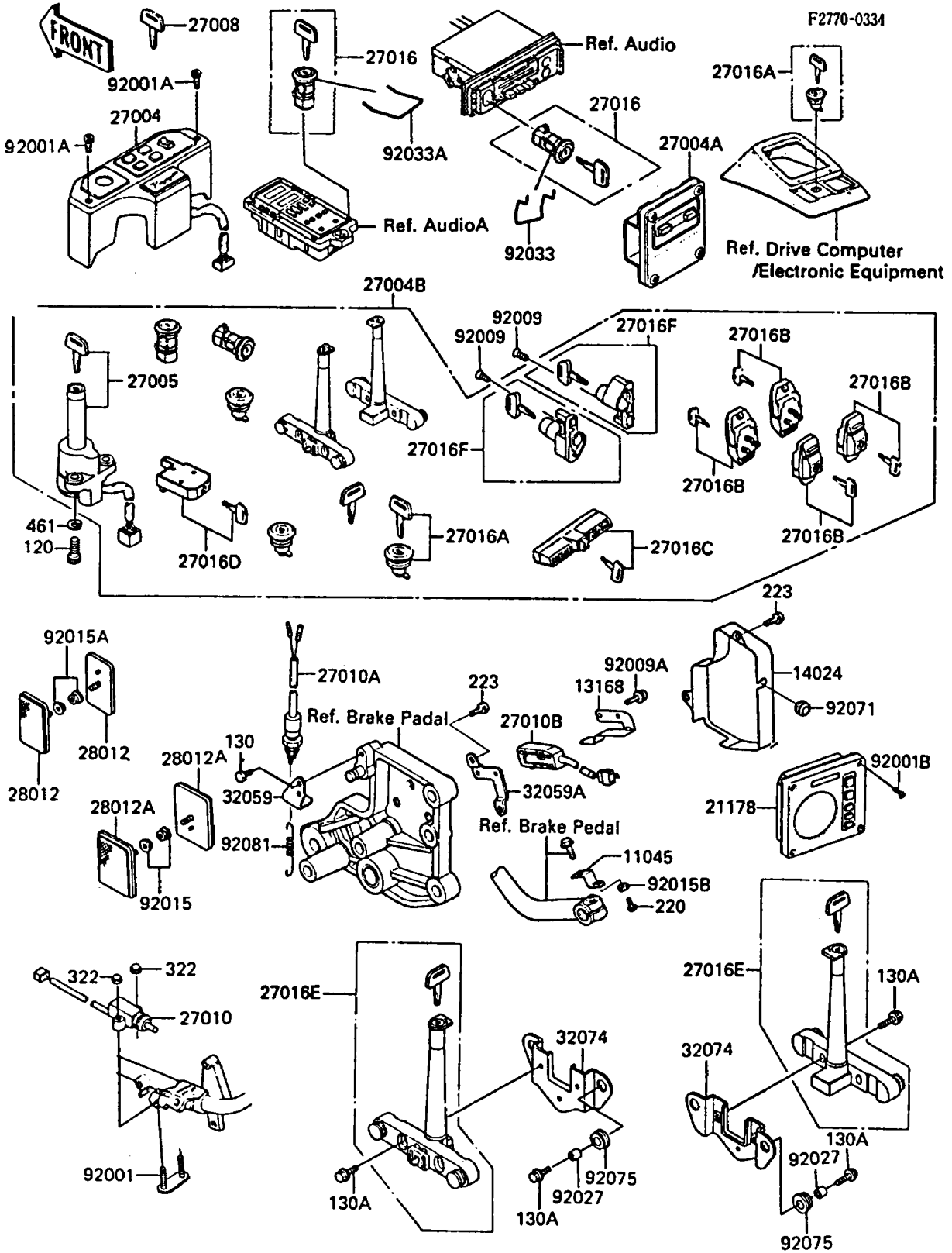

1988 Voyager PARTS LIST

Ignition Switch/Locks/Reflectors

ITEM NAME	PART NUMBER	QUANTITY
BRACKET,CRUISE CANCEL SWITCH (Ref # 11045)	11045-1982	1
LEVER,CRUISE CANCEL SWITCH (Ref # 13168)	13168-1364	1
COVER,CRUISE CANCEL SWITCH (Ref # 14024)	14024-1572	1
CONTROL-SWITCH (Ref # 21178)	21178-1001	1
SWITCH-ASSY,IGNITION BOX (Ref # 27004)	27004-1012	1
SWITCH-ASSY,CRUISE CONTROL (Ref # 27004A)	27004-1058	1
SWITCH-ASSY (Ref # 27004B)	27004-5214	1
SWITCH-ASSY-IGNITION (Ref # 27005)	27005-5034	1
KEY-LOCK,BLANK (Ref # 27008)	27008-1103	1
SWITCH,SIDE STAND (Ref # 27010)	27010-1151	1
SWITCH,BRAKE LAMP (Ref # 27010A)	27010-1181	1
SWITCH,CRUISE CANCEL (Ref # 27010B)	27010-1237	1
LOCK-ASSY,RADIO CONTROLER (Ref # 27016)	27016-5061	2
LOCK-ASSY (Ref # 27016A)	27016-5062	2
LOCK-ASSY,SIDE BAG (Ref # 27016B)	27016-5063	4
LOCK-ASSY,TRUNK (Ref # 27016C)	27016-5064	1
LOCK-ASSY,TRUNK (Ref # 27016D)	27016-5065	1
LOCK-ASSY,SIDE BAG (Ref # 27016E)	27016-5066	2
LOCK-ASSY,HELMET (Ref # 27016F)	27016-5067	2
REFLECTOR-REFLEX,FR (Ref # 28012)	28012-1009	2
REFLECTOR-REFLEX,RR (Ref # 28012A)	28012-1055	2
BRACKET-SWITCH (Ref # 32059)	32059-1027	1
BRACKET-SWITCH,CRUISE CANCEL (Ref # 32059A)	32059-1088	1
BRACKET-LOCK,SIDE BAG (Ref # 32074)	32074-1102	2
BOLT,SIDE STAND SWITCH (Ref # 92001)	92001-1961	1
BOLT,SOCKET,5X80 (Ref # 92001A)	92001-1978	2
BOLT,SOCKET,4X16 (Ref # 92001B)	92001-1996	4
SCREW,5X12 (Ref # 92009)	92009-1401	2
SCREW,4X16 (Ref # 92009A)	92009-1500	2

1988 Voyager PARTS LIST

Ignition Switch/Locks/Reflectors

ITEM NAME	PART NUMBER	QUANTITY
NUT,FLANGED,6MM (Ref # 92015)	92015-1193	2
NUT,FLANGED,5MM (Ref # 92015A)	92015-1259	2
NUT,4MM (Ref # 92015B)	92015-1676	1
COLLAR,L=11.1 (Ref # 92027)	92027-194	4
RING-SNAP,RADIO CONTROLER LOCK (Ref # 92033)	92033-1097	1
RING-SNAP,RADIO CONTROLER LOCK (Ref # 92033A)	92033-1098	1
GROMMET,10MM (Ref # 92071)	92071-019	1
DAMPER (Ref # 92075)	92075-277	4
SPRING,BRAKE SWITCH (Ref # 92081)	92081-1565	1
BOLT-SOCKET (Ref # 120)	120T0822	2
BOLT-FLANGED (Ref # 130)	130D0610	1
BOLT-FLANGED (Ref # 130A)	130D0620	8
SCREW-PAN-CROS (Ref # 220)	220B0420	1
SCREW-PAN-WS-CROS (Ref # 223)	223C0510	4
NUT-CAP (Ref # 322)	322C0500	2
WASHER-SPRING (Ref # 461)	461L0800	2