

1987 Voyager PARTS DIAGRAM

Chassis Electrical Equipment

F2760-0394

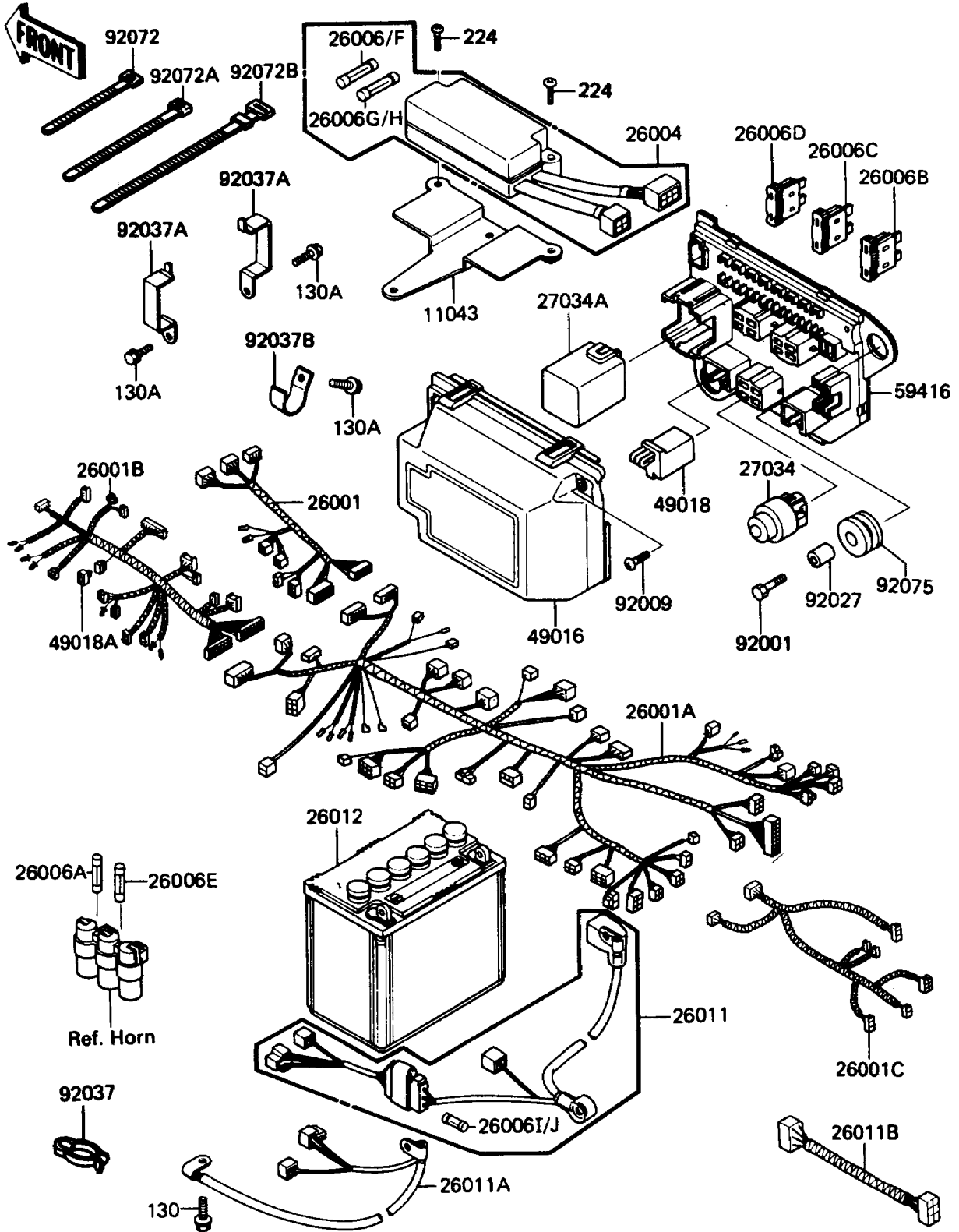

1987 Voyager PARTS LIST

Chassis Electrical Equipment

ITEM NAME	PART NUMBER	QUANTITY
BRACKET-B,SUB FUSE (Ref # 11043)	11043-1317	1
HARNESS,SUB,COWLING RH (Ref # 26001)	26001-1576	1
HARNESS,MAIN (Ref # 26001A)	26001-1868	1
HARNESS,SUB,COWLING,LH (Ref # 26001B)	26001-1869	1
HARNESS,RR (Ref # 26001C)	26001-1872	1
FUSE-ASSY (Ref # 26004)	26004-1052	1
FUSE,20A,L=25 (Ref # 26006)	26006-005	1
FUSE,20A,L=26 (Ref # 26006A)	26006-006	1
FUSE,30A-G (Ref # 26006B)	26006-1006	1
FUSE,10A-R (Ref # 26006C)	26006-1007	1
FUSE,20A-Y (Ref # 26006D)	26006-1051	1
FUSE,3A,L=30 (Ref # 26006E)	26006-1052	1
FUSE,5A,L=25 (Ref # 26006F)	26006-1053	1
FUSE,3A,L=30 (Ref # 26006G)	26006-1054	1
FUSE,1A,L=30 (Ref # 26006H)	26006-1055	1
FUSE,20A,L=30 (Ref # 26006I)	26006-1056	1
FUSE,1A,L=30 (Ref # 26006J)	26006-1057	1
WIRE-LEAD,BATTERY (Ref # 26011)	26011-1190	1
WIRE-LEAD,BATTERY GROUND (Ref # 26011A)	26011-1191	1
WIRE-LEAD,CRUISE CONTROL UNIT (Ref # 26011B)	26011-1410	1
BATTERY,12V24AH,12N24-3(YUASA) (Ref # 26012)	26012-1079	1
RELAY,STARTER (Ref # 27034)	27034-1006	1
RELAY,FLASHER (Ref # 27034A)	27034-1007	1
COVER-SEAL (Ref # 49016)	49016-1050	1
DIODE (Ref # 49018)	49018-1006	1
DIODE (Ref # 49018A)	49018-1055	1
CASE-ELECTRIC (Ref # 59416)	59416-1056	1
BOLT,6X22 (Ref # 92001)	92001-1774	1
SCREW,TAPPING,4X10 (Ref # 92009)	92009-1021	1

1987 Voyager PARTS LIST

Chassis Electrical Equipment

ITEM NAME	PART NUMBER	QUANTITY
COLLAR,6.8X10X12 (Ref # 92027)	92027-162	1
CLAMP,CABLE (Ref # 92037)	92037-093	1
CLAMP,HARNESS (Ref # 92037A)	92037-1469	1
CLAMP,HARNESS (Ref # 92037B)	92037-1492	1
BAND,L=123 (Ref # 92072)	92072-030	1
BAND,L=218 (Ref # 92072A)	92072-032	1
BAND,L=186 (Ref # 92072B)	92072-056	1
DAMPER (Ref # 92075)	92075-1562	1
BOLT-FLANGED,6X10 (Ref # 130)	130B0610	1
BOLT-FLANGED,6X10,BLACK (Ref # 130A)	130C0610	1
SCREW-PAN-WP-CROS (Ref # 224)	224C0520	1