

1987 Voyager PARTS DIAGRAM

Turn Signals

F2730-0129

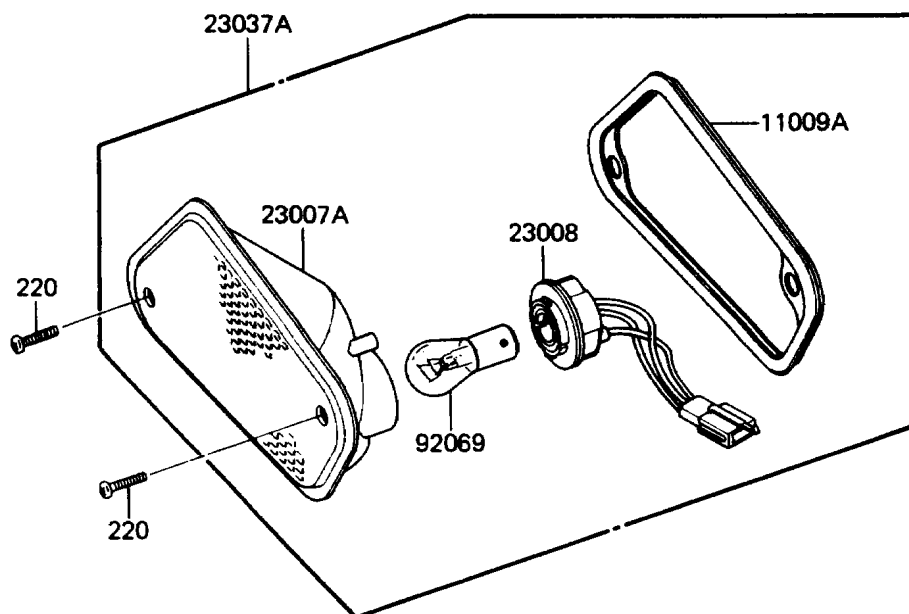
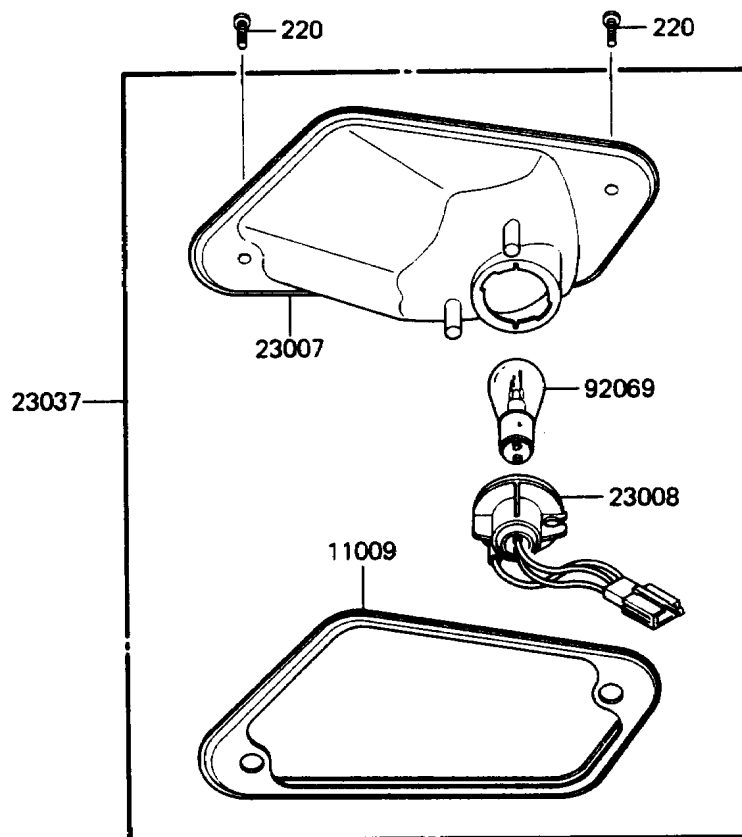

1987 Voyager PARTS LIST

Turn Signals

ITEM NAME	PART NUMBER	QUANTITY
GASKET,SIGNAL LAMP,FR,RH (Ref # 11009)	11009-1339	1
GASKET,SIGNAL LAMP,FR,LH (Ref # 11009A)	11009-1340	1
LENS-COMP,SIGNAL LAMP,FR,RH (Ref # 23007)	23007-1056	1
LENS-COMP,SIGNAL LAMP,FR,LH (Ref # 23007A)	23007-1057	1
SOCKET-ASSY,SIGNAL LAMP,FR (Ref # 23008)	23008-1184	1
LAMP-ASSY-SIGNAL,FR,RH (Ref # 23037)	23037-1148	1
LAMP-ASSY-SIGNAL,FR,LH (Ref # 23037A)	23037-1149	1
BULB,12V 32/3CP(23/8W) (Ref # 92069)	92069-060	1
SCREW-PAN-CROS (Ref # 220)	220B0420	1