

1997 Eliminator 600 PARTS DIAGRAM

Footrests

F2160

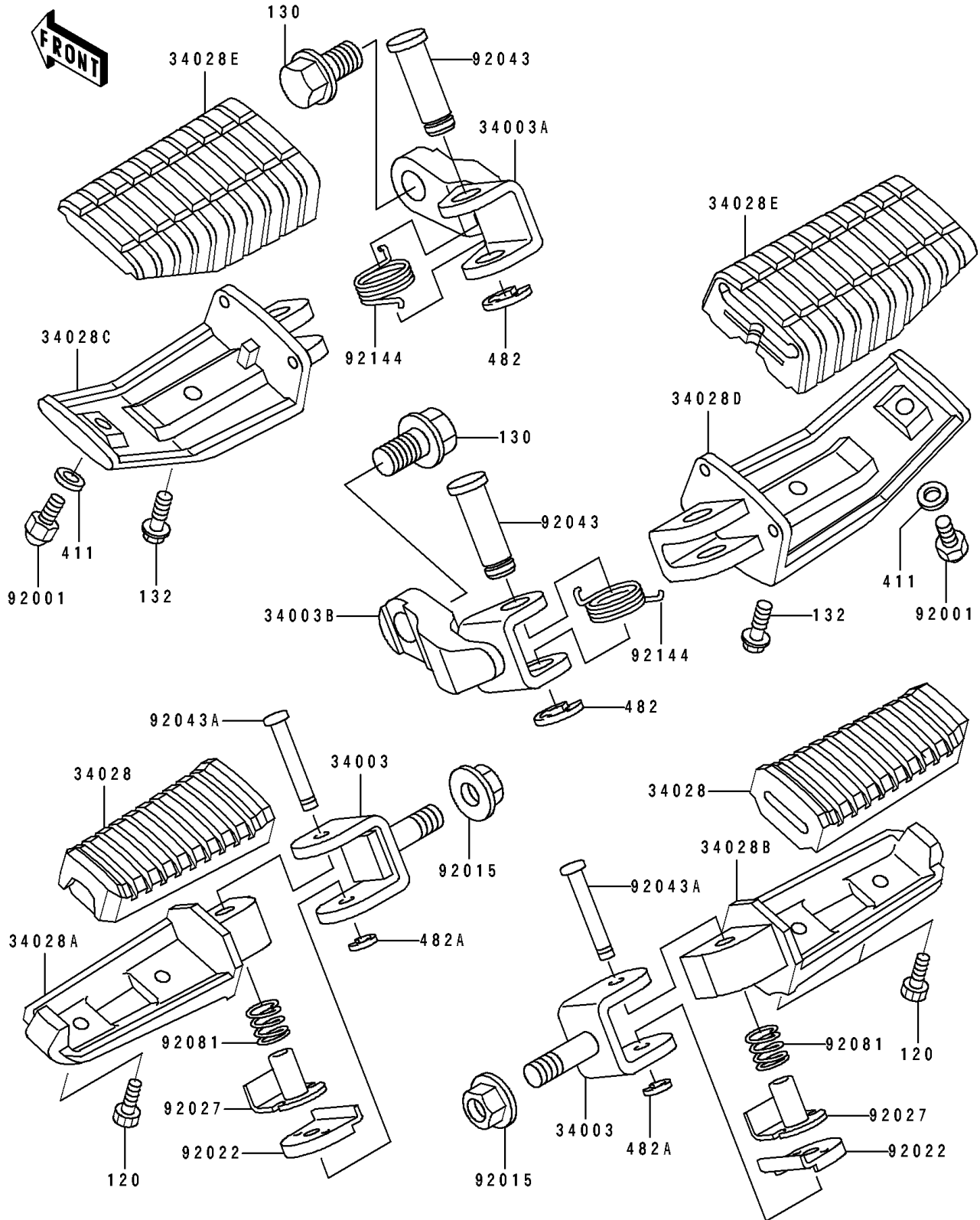

1997 Eliminator 600 PARTS LIST

Footrests

ITEM NAME	PART NUMBER	QUANTITY
HOLDER-STEP,RR (Ref # 34003)	34003-1240	1
HOLDER-STEP,FR,LH (Ref # 34003A)	34003-1257	1
HOLDER-STEP,FR,RH (Ref # 34003B)	34003-1277	1
STEP,RR,RUBBER (Ref # 34028)	34028-1060	1
STEP,RR,LH (Ref # 34028A)	34028-1158	1
STEP,RR,RH (Ref # 34028B)	34028-1159	1
STEP,FR,LH (Ref # 34028C)	34028-1162	1
STEP,FR,RH (Ref # 34028D)	34028-1163	1
STEP,FR,RUBBER (Ref # 34028E)	34028-1164	1
BOLT,6X10 (Ref # 92001)	92001-1905	1
NUT,FLANGED,10MM (Ref # 92015)	92015-1428	1
WASHER,STEP,RR (Ref # 92022)	92022-1507	1
COLLAR,STEP (Ref # 92027)	92027-1732	1
PIN,12X37 (Ref # 92043)	92043-1144	1
PIN,6X35.5 (Ref # 92043A)	92043-1294	1
SPRING,STEP,RR (Ref # 92081)	92081-1612	1
SPRING,STEP RETURN (Ref # 92144)	92144-1568	1
BOLT-SOCKET (Ref # 120)	120Z0514	1
BOLT-FLANGED (Ref # 130)	130C1220	1
BOLT-FLANGED-SMALL (Ref # 132)	132G0616	1
WASHER-PLAIN,6MM (Ref # 411)	411B0600	1
CIRCLIP-TYPE-E,10MM (Ref # 482)	482L0100	1
CIRCLIP-TYPE-E,5MM (Ref # 482A)	482L5000	1