

1997 Eliminator 600 PARTS DIAGRAM

Frame Fittings

F2131

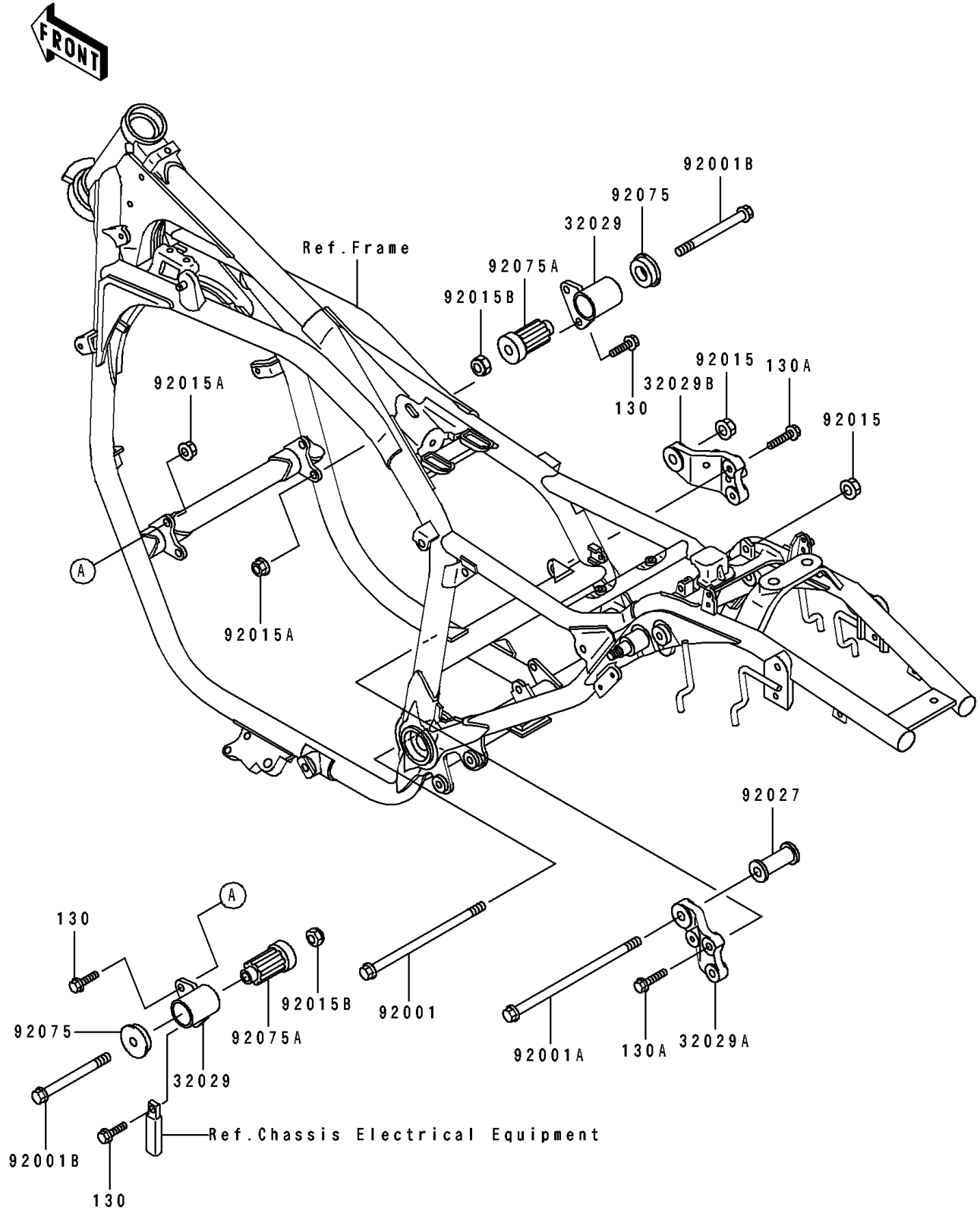

1997 Eliminator 600 PARTS LIST

Frame Fittings

ITEM NAME	PART NUMBER	QUANTITY
BRACKET-ENGINE,FR (Ref # 32029)	32029-1464	2
BRACKET-ENGINE,RR,UPP,LH (Ref # 32029A)	32029-1465	1
BRACKET-ENGINE,RR,UPP,RH (Ref # 32029B)	32029-1466	1
BOLT,FLANGED,10X180 (Ref # 92001)	92001-1621	1
BOLT,FLANGED,10X200,BLACK (Ref # 92001A)	92001-1677	1
BOLT,FLANGED,10X105,BLACK (Ref # 92001B)	92001-1751	2
NUT,FLANGED,10MM (Ref # 92015)	92015-1180	2
NUT,FLANGED,8MM,BLACK (Ref # 92015A)	92015-1183	4
NUT,LOCK,10MM,BLACK (Ref # 92015B)	92015-1189	2
COLLAR,L=54 (Ref # 92027)	92027-275	1
DAMPER,ENGINE BRACKET (Ref # 92075)	92075-1738	2
DAMPER,ENGINE MOUNT,MAIN (Ref # 92075A)	92075-1739	2
BOLT-FLANGED,8X20 (Ref # 130)	130J0820	4
BOLT-FLANGED,8X25,BLACK (Ref # 130A)	130J0825	4