

1997 Eliminator 600 PARTS DIAGRAM

Gear Change Drum/Shift Fork(s)

E1362

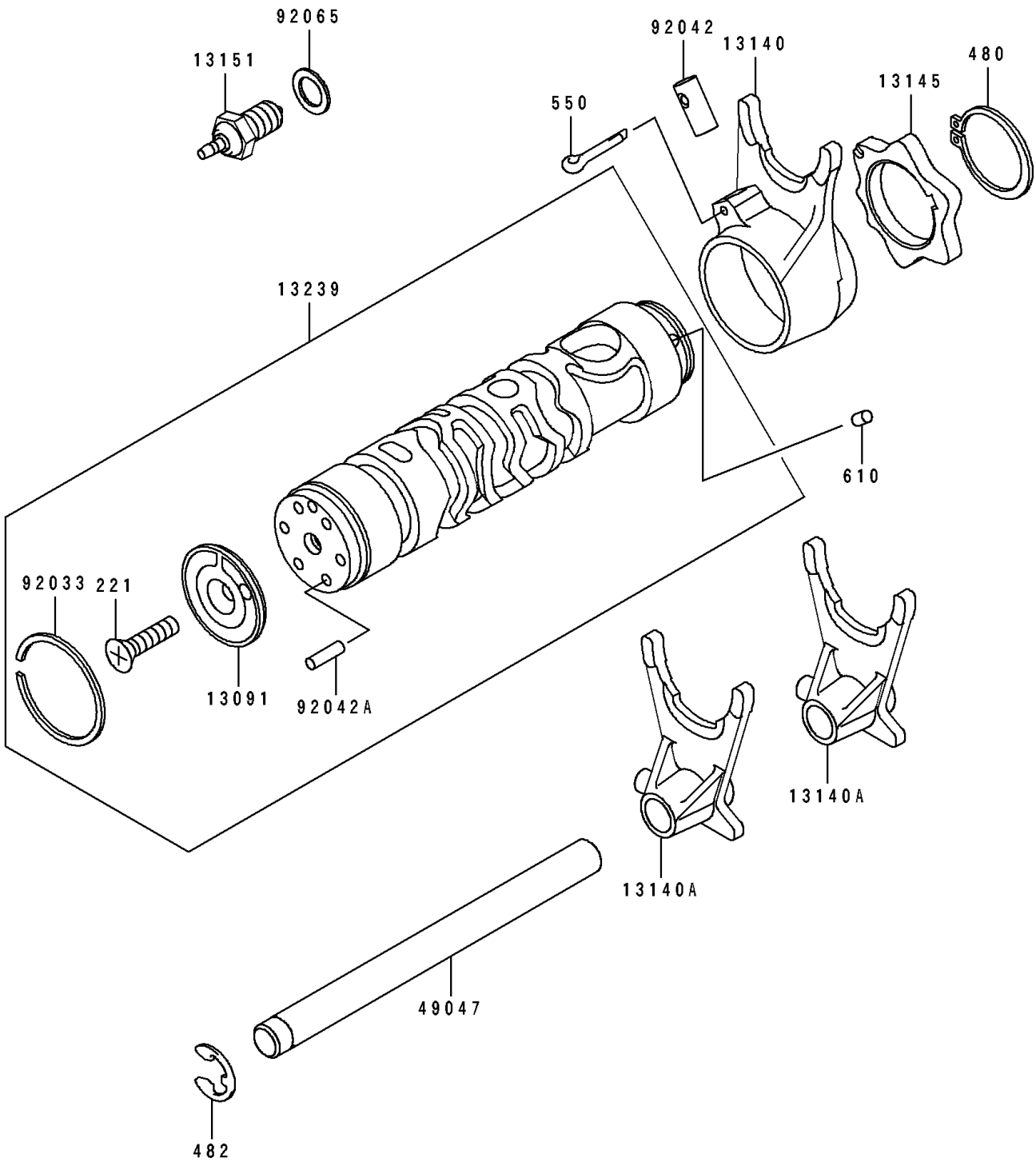

1997 Eliminator 600 PARTS LIST

Gear Change Drum/Shift Fork(s)

ITEM NAME	PART NUMBER	QUANTITY
HOLDER,CHANGE DRUM PIN (Ref # 13091)	13091-1104	1
FORK-SHIFT,DRIVE (Ref # 13140)	13140-1016	1
FORK-SHIFT,OUTPUT (Ref # 13140A)	13140-1062	1
CAM-CHANGE DRUM (Ref # 13145)	13145-1058	1
SWITCH-COMP,NEUTRAL (Ref # 13151)	13151-1080	1
DRUM-ASSY-CHANGE (Ref # 13239)	13239-1196	1
ROD-SHIFT (Ref # 49047)	49047-1069	1
RING-SNAP,37MM (Ref # 92033)	92033-035	1
PIN,DOWEL,8X18 (Ref # 92042)	92042-021	1
PIN,DOWEL,4X13.8 (Ref # 92042A)	92042-030	1
GASKET,10.5X16X1,DRAIN PLUG (Ref # 92065)	92065-058	1
SCREW-CSK-CROS,6X20 (Ref # 221)	221B0620	1
CIRCLIP-TYPE-C,30MM (Ref # 480)	480J3000	1
CIRCLIP-TYPE-E,10MM (Ref # 482)	482J0100	1
PIN-COTTER,3.0X20 (Ref # 550)	550D3020	1
ROLLER,4X6 (Ref # 610)	610A0406	1