

1997 Eliminator 600 PARTS DIAGRAM

Clutch

E1350

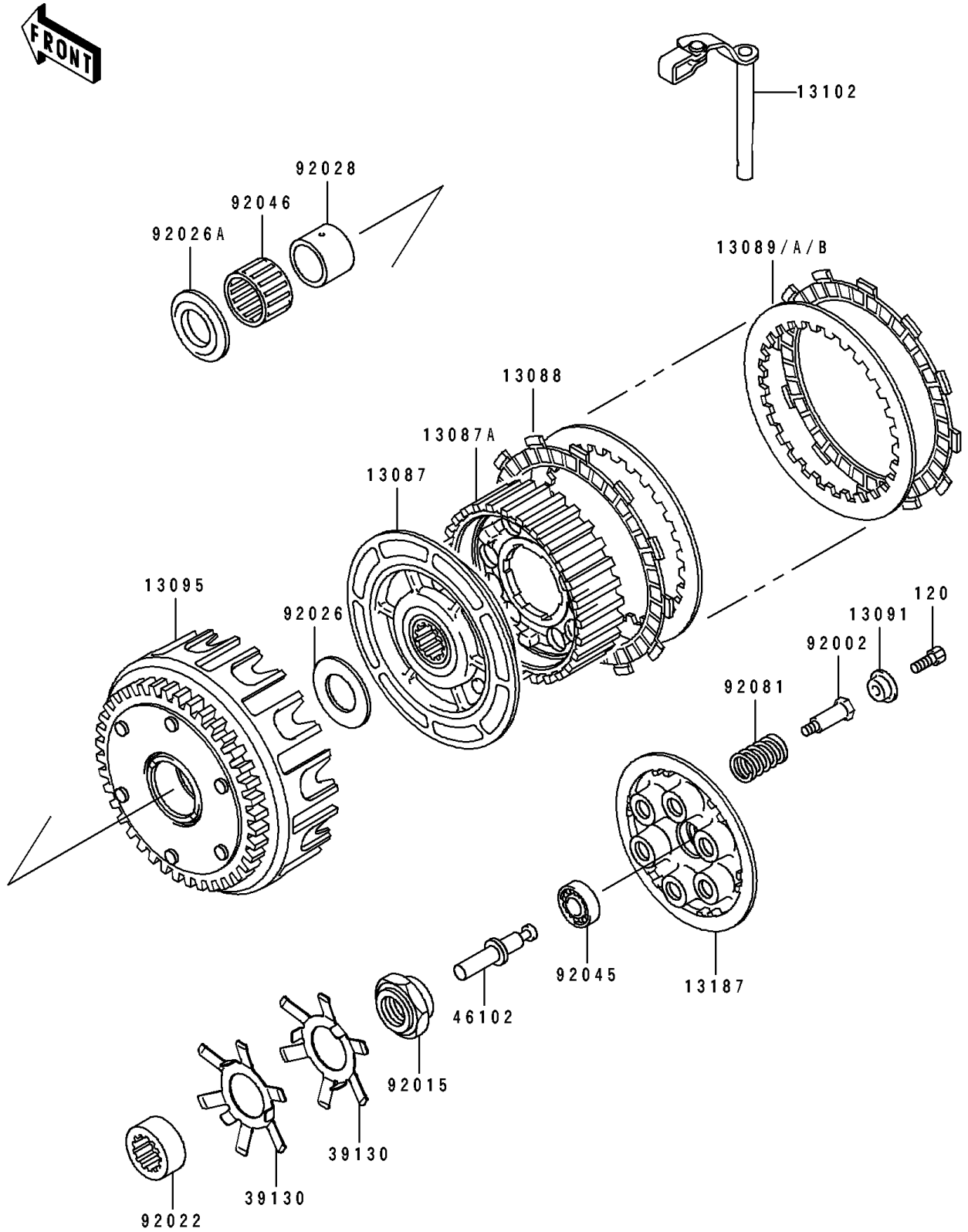

1997 Eliminator 600 PARTS LIST

Clutch

ITEM NAME	PART NUMBER	QUANTITY
HUB-CLUTCH (Ref # 13087)	13087-1079	1
HUB-CLUTCH (Ref # 13087A)	13087-1080	1
PLATE-FRICTION (Ref # 13088)	13088-040	1
PLATE-CLUTCH,T=2.0 (Ref # 13089)	13089-026	1
PLATE-CLUTCH,T=2.3 (Ref # 13089A)	13089-1004	1
PLATE-CLUTCH,T=2.6 (Ref # 13089B)	13089-1067	1
HOLDER,CLUTCH SPRING (Ref # 13091)	13091-1041	1
HOUSING-COMP-CLUTCH (Ref # 13095)	13095-1312	1
RELEASE-COMP-CLUTCH (Ref # 13102)	13102-1080	1
PLATE-CLUTCH OPERATING (Ref # 13187)	13187-1058	1
SPRING-LEAF (Ref # 39130)	39130-1071	1
ROD,CLUTCH (Ref # 46102)	46102-1030	1
BOLT,CLUTCH (Ref # 92002)	92002-1639	1
NUT (Ref # 92015)	92015-1929	1
WASHER,TOOTHED,21.7X36X15.5 (Ref # 92022)	92022-1782	1
SPACER,25.5X47X2.5 (Ref # 92026)	92026-022	1
SPACER,THRUST,T=5.5 (Ref # 92026A)	92026-116	1
BUSHING,25X32X23.6 (Ref # 92028)	92028-178	1
BEARING-BALL,6001C3ML01 (Ref # 92045)	92045-1235	1
BEARING-NEEDLE,KTV323723 (Ref # 92046)	92046-028	1
SPRING,CLUTCH (Ref # 92081)	92081-1114	1
BOLT-SOCKET,6X16 (Ref # 120)	120Q0616	1