

# 1992 Voyager XII PARTS DIAGRAM

Ignition Switch/Locks/Reflectors

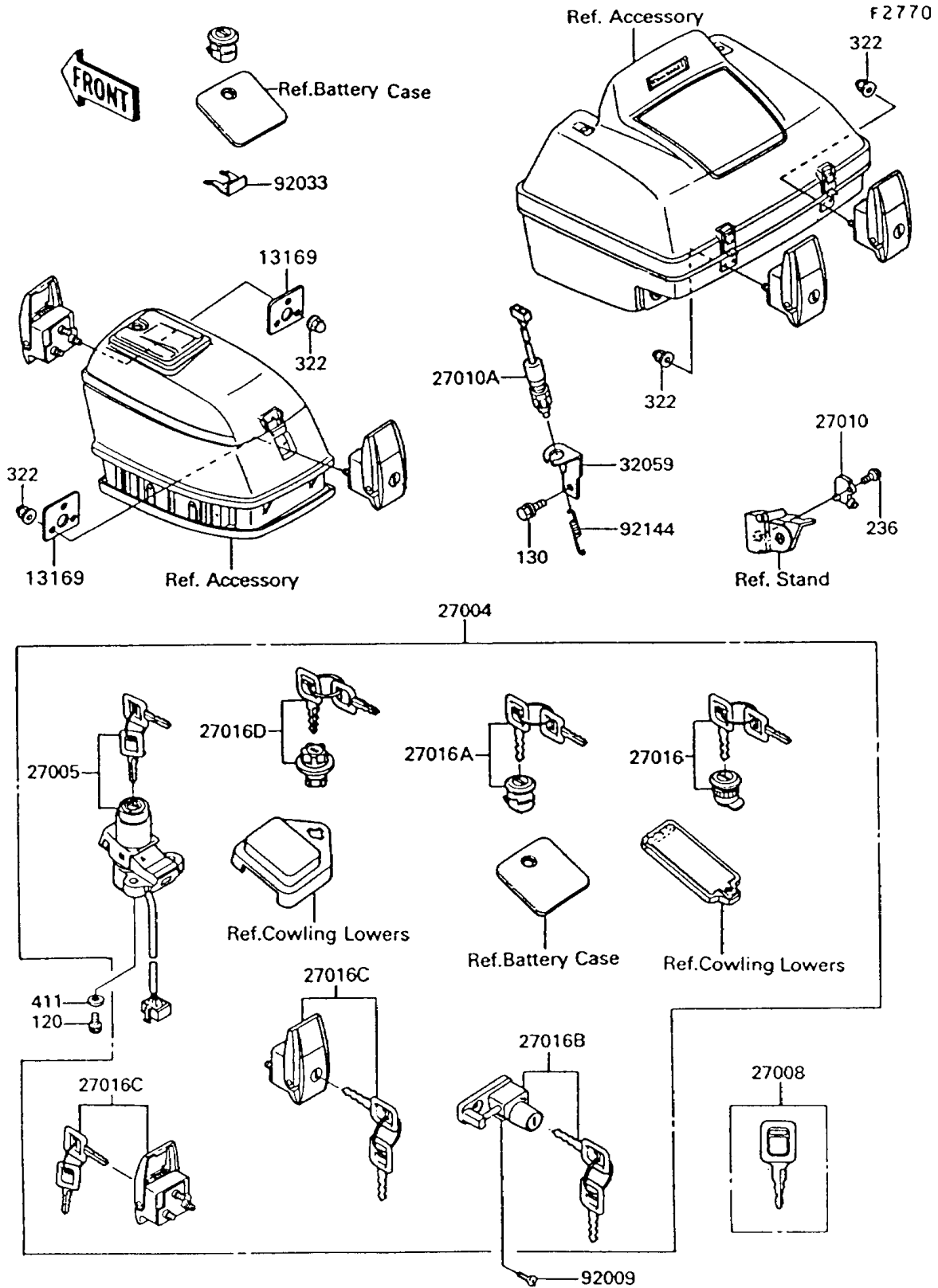

# 1992 Voyager XII PARTS LIST

## Ignition Switch/Locks/Reflectors

ITEM NAME	PART NUMBER	QUANTITY
BOLT-SOCKET (Ref # 120)	120T0616	2
BOLT-FLANGED (Ref # 130)	130D0610	1
SCREW-PAN-WSP-CROS (Ref # 236)	236B0416	1
NUT-CAP,4MM (Ref # 322)	322C0400	18
WASHER-PLAIN,6MM (Ref # 411)	411E0600	2
PLATE,BAG (Ref # 13169)	13169-1641	4
SWITCH-ASSY (Ref # 27004)	27004-5318	1
SWITCH-ASSY-IGNITION (Ref # 27005)	27005-5063	1
KEY-LOCK,BLANK (Ref # 27008)	27008-1103	1
SWITCH,BRAKE/SIDE STAND (Ref # 27010)	27010-1185	1
SWITCH,REAR BRAKE (Ref # 27010A)	27010-1200	1
LOCK-ASSY (Ref # 27016)	27016-5105	1
LOCK-ASSY,TANK CAP COVER (Ref # 27016A)	27016-5106	1
LOCK-ASSY,HELMET (Ref # 27016B)	27016-5107	2
LOCK-ASSY,BAG (Ref # 27016C)	27016-5108	6
LOCK-ASSY,FAIRING POCKET (Ref # 27016D)	27016-5128	1
BRACKET-SWITCH,REAR BRAKE (Ref # 32059)	32059-1068	1
SCREW,5X12 (Ref # 92009)	92009-1401	2
RING-SNAP,COWLING POCKET (Ref # 92033)	92033-1095	1
SPRING,REAR BRAKE (Ref # 92144)	92144-1015	1