

1992 Voyager XII PARTS DIAGRAM

Brake Pedal/Torque Link

F2260

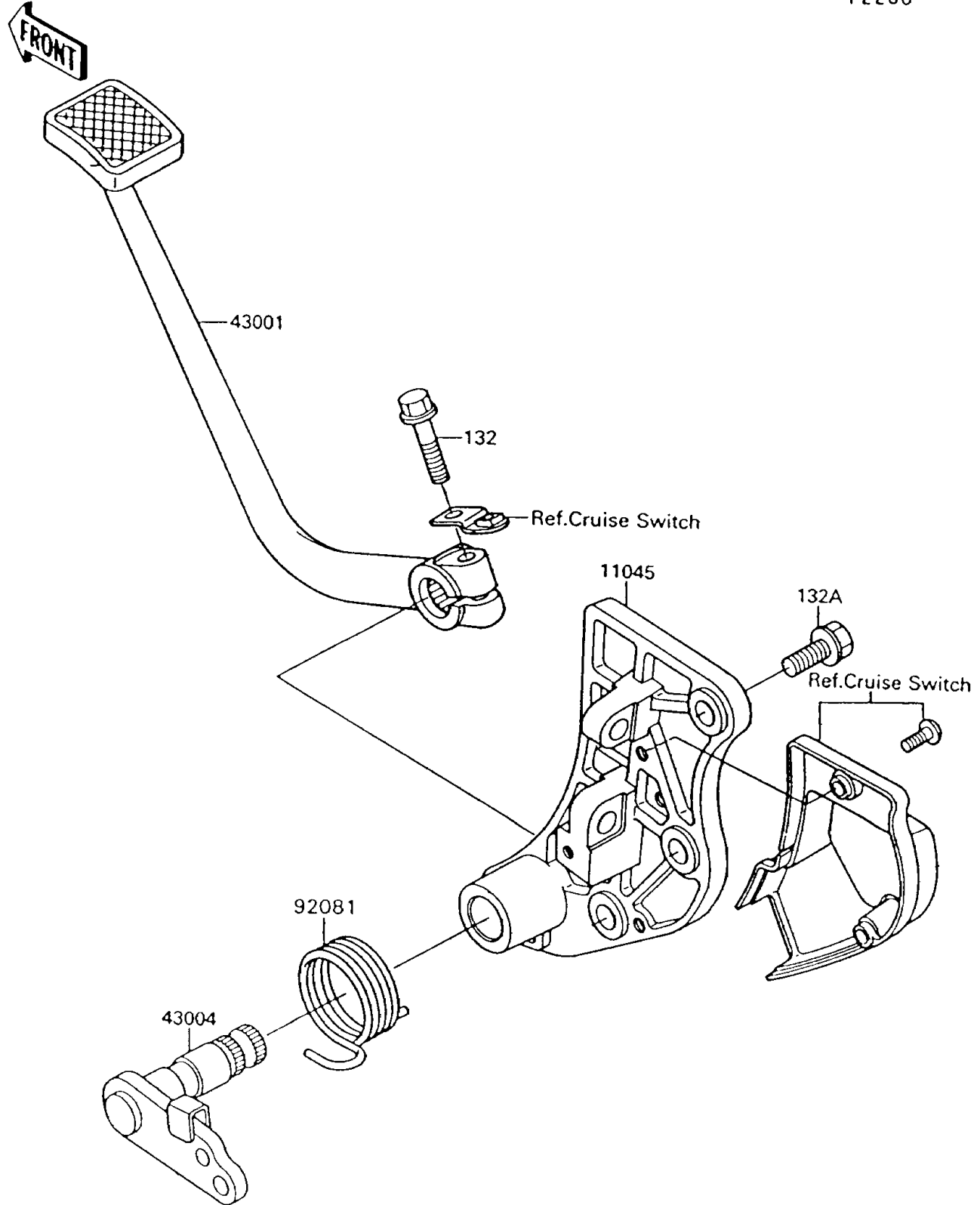

1992 Voyager XII PARTS LIST

Brake Pedal/Torque Link

ITEM NAME	PART NUMBER	QUANTITY
BOLT-FLANGED-SMALL (Ref # 132)	132E0825	1
BOLT-FLANGED-SMALL,8X16 (Ref # 132A)	132J0816	3
BRACKET,BRAKE PEDAL (Ref # 11045)	11045-1910	1
LEVER-BRAKE,PEDAL (Ref # 43001)	43001-1235	1
SHAFT-BRAKE (Ref # 43004)	43004-1119	1
SPRING,BRAKE PEDAL RETURN (Ref # 92081)	92081-1955	1