

1994 Voyager XII PARTS DIAGRAM

Front Bevel Gear

E3131

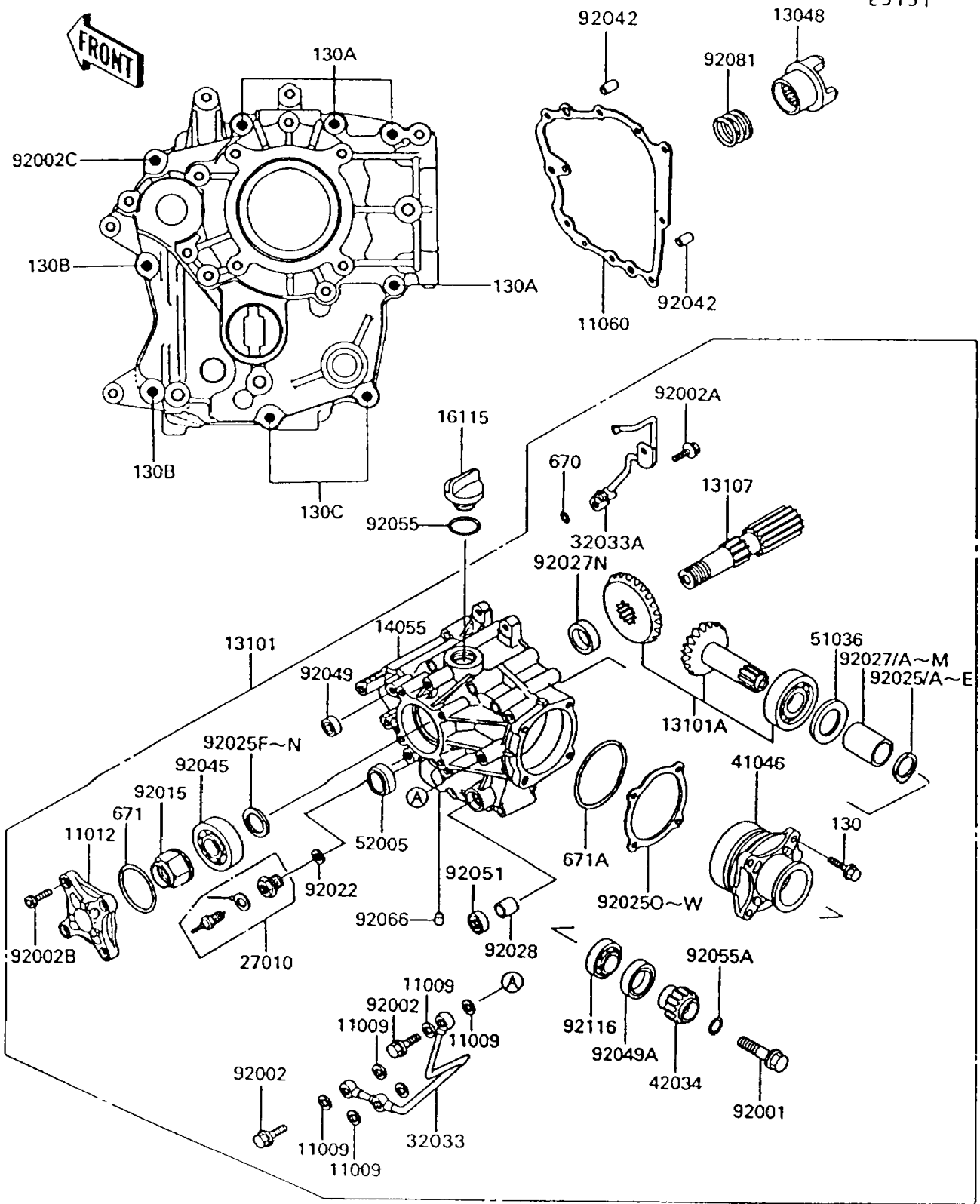

1994 Voyager XII PARTS LIST

Front Bevel Gear

ITEM NAME	PART NUMBER	QUANTITY
GASKET,OIL PIPE,8.2X14X1.0 (Ref # 11009)	11009-1344	6
CAP,BEARING (Ref # 11012)	11012-1489	1
GASKET,GEAR CASE (Ref # 11060)	11060-1094	1
CAM-DAMPER (Ref # 13048)	13048-1074	1
GEAR-ASSY,FRONT BEVEL (Ref # 13101)	13101-1089	1
GEAR-ASSY,FRONT BEVEL (Ref # 13101A)	13101-5027	1
SHAFT,BEVEL,FR (Ref # 13107)	13107-1263	1
CASE-GEAR,FRONT BEVEL (Ref # 14055)	14055-1066	1
CAP-OIL FILLER (Ref # 16115)	16115-1009	1
SWITCH,OVER DRIVE (Ref # 27010)	27010-1224	1
PIPE,OUTSIDE (Ref # 32033)	32033-1940	1
PIPE,INSIDE (Ref # 32033A)	32033-1941	1
HOUSING-BEARING (Ref # 41046)	41046-1074	1
COUPLING,FR DRIVEN (Ref # 42034)	42034-1091	1
CUP (Ref # 51036)	51036-1002	1
GAUGE,OIL LEVEL (Ref # 52005)	52005-1057	1
BOLT,FLANGED,12X42 (Ref # 92001)	92001-1169	1
BOLT,BANJO,8X20 (Ref # 92002)	92002-1618	3
BOLT,6X14 (Ref # 92002A)	92002-1656	2
BOLT,SOCKET,6X25 (Ref # 92002B)	92002-1696	4
BOLT,6X50 (Ref # 92002C)	92002-1779	1
NUT,24MM (Ref # 92015)	92015-1554	1
WASHER,16XX22X1.0 (Ref # 92022)	92022-1812	1
SHIM,25.2X29.8X1.70 (Ref # 92025)	92025-1072	AR
SHIM,25.2X29.8X1.72 (Ref # 92025A)	92025-1073	AR
SHIM,25.2X29.8X1.74 (Ref # 92025B)	92025-1074	AR
SHIM,25.2X29.8X1.76 (Ref # 92025C)	92025-1075	AR
SHIM,25.2X29.8X1.78 (Ref # 92025D)	92025-1076	AR
SHIM,25.2X29.8X1.80 (Ref # 92025E)	92025-1077	AR

1994 Voyager XII PARTS LIST

Front Bevel Gear

ITEM NAME	PART NUMBER	QUANTITY
SHIM,25.3X36X0.15 (Ref # 92025F)	92025-1688	AR
SHIM,25.3X36X0.50 (Ref # 92025G)	92025-1689	AR
SHIM,25.3X36X0.60 (Ref # 92025H)	92025-1690	AR
SHIM,25.3X36X0.70 (Ref # 92025I)	92025-1691	AR
SHIM,25.3X36X0.80 (Ref # 92025J)	92025-1692	AR
SHIM,25.3X36X0.90 (Ref # 92025K)	92025-1693	AR
SHIM,25.3X36X1.00 (Ref # 92025L)	92025-1694	AR
SHIM,25.3X36X1.10 (Ref # 92025M)	92025-1695	AR
SHIM,25.3X36X1.20 (Ref # 92025N)	92025-1696	AR
SHIM,T=0.10 (Ref # 92025O)	92025-1724	AR
SHIM,T=0.15 (Ref # 92025P)	92025-1725	AR
BOLT-FLANGED,6X25 (Ref # 130)	130P0625	4
BOLT-FLANGED (Ref # 130A)	130Z06100	4
BOLT-FLANGED (Ref # 130B)	130Z0630	2
BOLT-FLANGED (Ref # 130C)	130Z0650	2
O RING,6MM (Ref # 670)	670B1506	1
O RING,65MM (Ref # 671)	671B2565	1
O RING (Ref # 671A)	671B2575	1
SHIM,T=0.50 (Ref # 92025Q)	92025-1726	AR
SHIM,T=0.60 (Ref # 92025R)	92025-1727	AR
SHIM,T=0.70 (Ref # 92025S)	92025-1728	AR
SHIM,T=0.80 (Ref # 92025T)	92025-1729	AR
SHIM,T=0.90 (Ref # 92025U)	92025-1730	AR
SHIM,T=1.00 (Ref # 92025V)	92025-1731	AR
SHIM,T=1.20 (Ref # 92025W)	92025-1732	AR
COLLAR,25.2X29.8X22.8 (Ref # 92027)	92027-1152	AR
COLLAR,25.2X29.8X22.9 (Ref # 92027A)	92027-1153	AR
COLLAR,25.2X29.8X23 (Ref # 92027B)	92027-1154	AR
COLLAR,25.2X29.8X23.1 (Ref # 92027C)	92027-1155	AR

1994 Voyager XII PARTS LIST

Front Bevel Gear

ITEM NAME	PART NUMBER	QUANTITY
COLLAR,25.2X29.8X23.2 (Ref # 92027D)	92027-1156	AR
COLLAR,25.2X29.8X23.3 (Ref # 92027E)	92027-1157	AR
COLLAR,25.2X29.8X23.4 (Ref # 92027F)	92027-1158	AR
COLLAR,25.2X29.8X23.5 (Ref # 92027G)	92027-1159	AR
COLLAR,25.2X29.8X23.6 (Ref # 92027H)	92027-1160	AR
COLLAR,25.2X29.8X23.7 (Ref # 92027I)	92027-1161	AR
COLLAR,25.2X29.8X23.8 (Ref # 92027J)	92027-1162	AR
COLLAR,25.2X29.8X23.9 (Ref # 92027K)	92027-1163	AR
COLLAR,25.2X29.8X24 (Ref # 92027L)	92027-1164	AR
COLLAR,25.2X29.8X24.1 (Ref # 92027M)	92027-1165	AR
COLLAR,25.3X36X10 (Ref # 92027N)	92027-1968	1
BUSHING,13X15X20 (Ref # 92028)	92028-1251	1
PIN,DOWEL,6.3X8X14 (Ref # 92042)	92042-007	2
BEARING-BALL,6305C2 (Ref # 92045)	92045-1165	1
SEAL-OIL,SD-8187 (Ref # 92049)	92049-1017	1
SEAL-OIL,TC35527 (Ref # 92049A)	92049-1038	1
SEAL-OIL,TB13225.5 (Ref # 92051)	92051-005	1
RING-O,31.5X2.6 (Ref # 92055)	92055-049	1
RING-O,ID=18.64 (Ref # 92055A)	92055-1044	1
PLUG,OIL LINE,7.2X8 (Ref # 92066)	92066-1012	1
SPRING,CAM DAMPER (Ref # 92081)	92081-1859	1
BEARING-ROLLER,4T30205 (Ref # 92116)	92116-1003	1