

1997 Voyager XII PARTS DIAGRAM

Front Brake

F2292

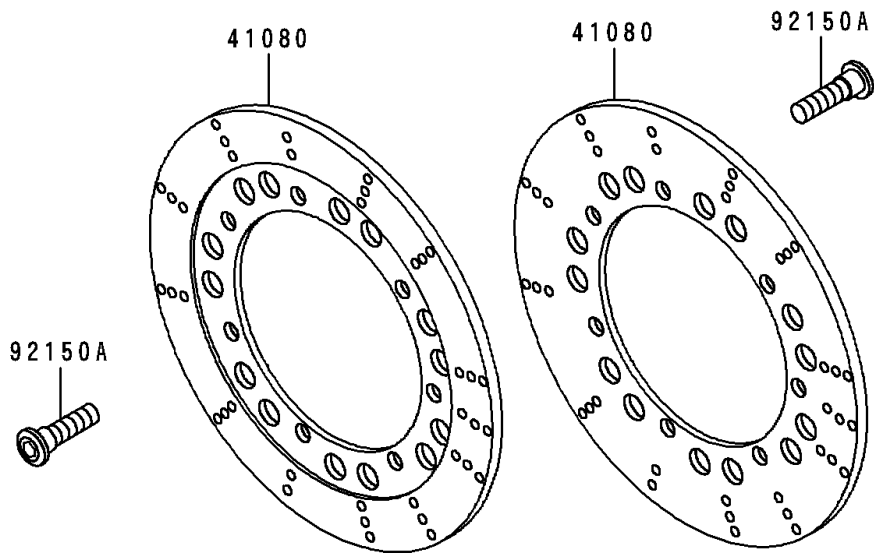
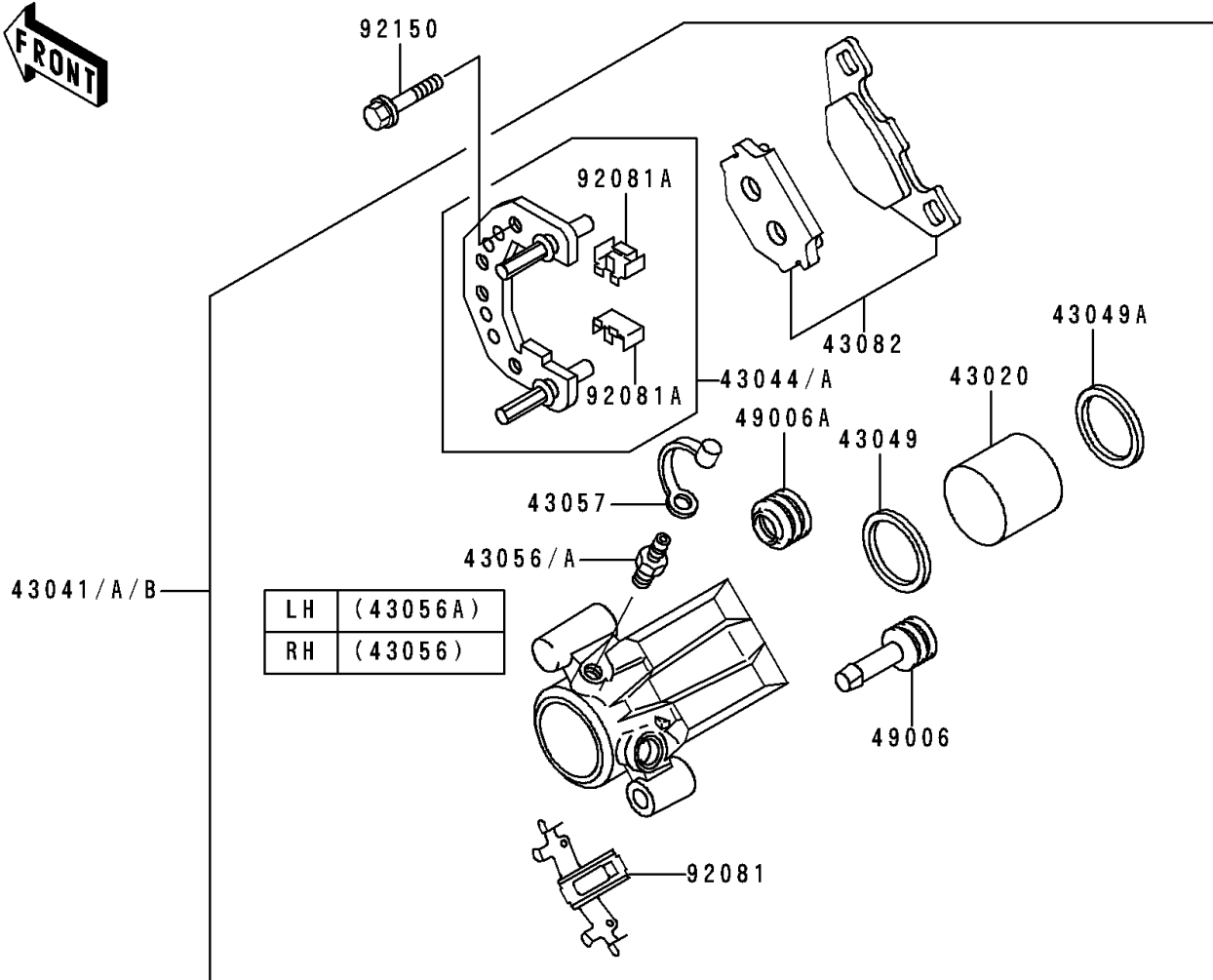

1997 Voyager XII PARTS LIST

Front Brake

ITEM NAME	PART NUMBER	QUANTITY
DISC,FR (Ref # 41080)	41080-1163	2
PISTON-COMP-BRAKE (Ref # 43020)	43020-1066	2
CALIPER-ASSY,FR,LH (Ref # 43041)	43041-1472	1
CALIPER-ASSY,FR,RH (Ref # 43041B)	43041-1615	1
HOLDER-COMP-CALIPER,FR,LH (Ref # 43044)	43044-1035	1
HOLDER-COMP-CALIPER,FR,RH (Ref # 43044A)	43044-1036	1
RING,PISTON SEAL (Ref # 43049)	43049-002	2
PACKING,PISTON (Ref # 43049A)	43049-1028	2
BREATHER (Ref # 43056)	43056-003	1
BREATHER-BRAKE (Ref # 43056A)	43056-1054	1
CAP-BREATHER (Ref # 43057)	43057-003	2
PAD-ASSY-BRAKE (Ref # 43082)	43082-1062	2
BOOT,CALIPER (Ref # 49006)	49006-1094	2
BOOT,CALIPER (Ref # 49006A)	49006-1095	2
SPRING,PAD (Ref # 92081)	92081-1525	2
SPRING,PAD STOPPER (Ref # 92081A)	92081-1661	4
BOLT,FLANGED,10X41 (Ref # 92150)	92150-1004	4
BOLT,SOCKET,8X30 (Ref # 92150A)	92150-1771	14