

1996 Voyager XII PARTS DIAGRAM

Tires

F2210

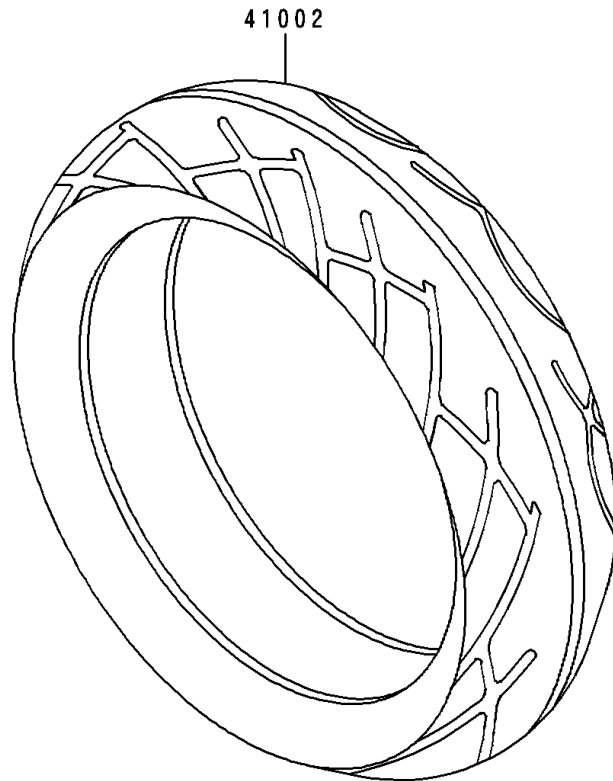
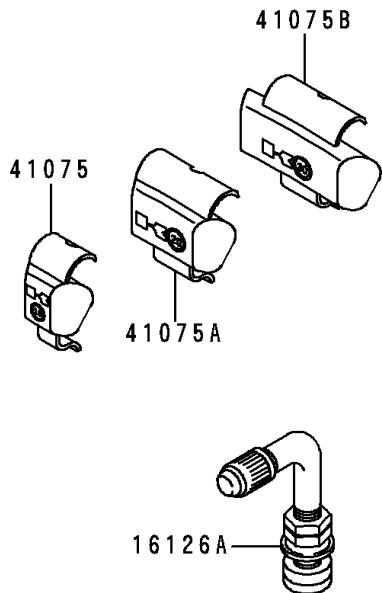
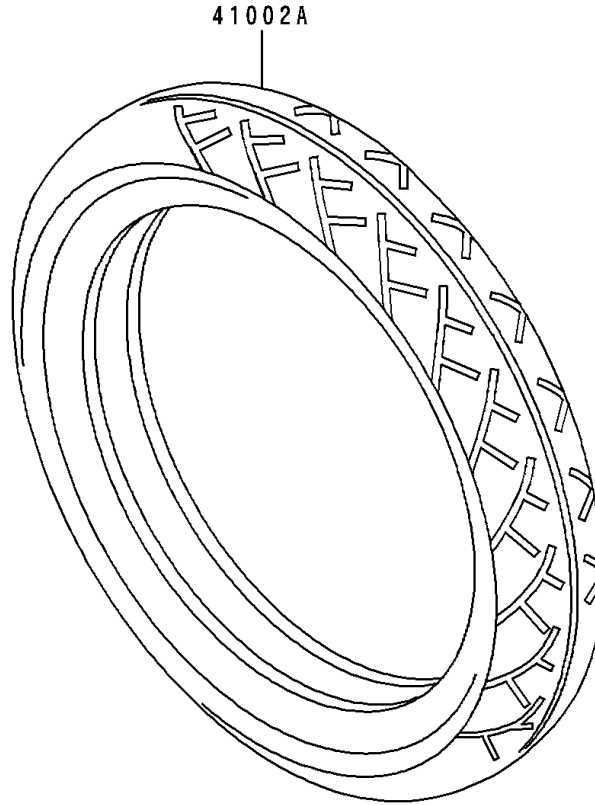
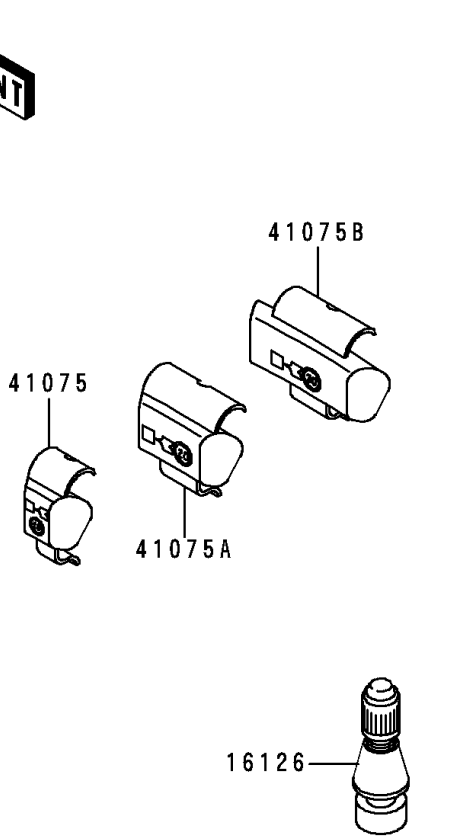

1996 Voyager XII PARTS LIST

Tires

ITEM NAME	PART NUMBER	QUANTITY
VALVE,TIRE (Ref # 16126)	16126-1140	1
VALVE,TIRE (Ref # 16126A)	16126-1191	1
TIRE,RR,M150/90-15,K425A(D) (Ref # 41002)	41002-1658	1
TIRE,FR,M130/90-16,F21(D) (Ref # 41002A)	41002-1659	1
BALANCER-WHEEL,10G,SILVER (Ref # 41075)	41075-1014	AR
BALANCER-WHEEL,20G,SILVER (Ref # 41075A)	41075-1015	AR
BALANCER-WHEEL,30G,SILVER (Ref # 41075B)	41075-1016	AR