

2021 Z400 ABS PARTS DIAGRAM

Chassis Electrical Equipment

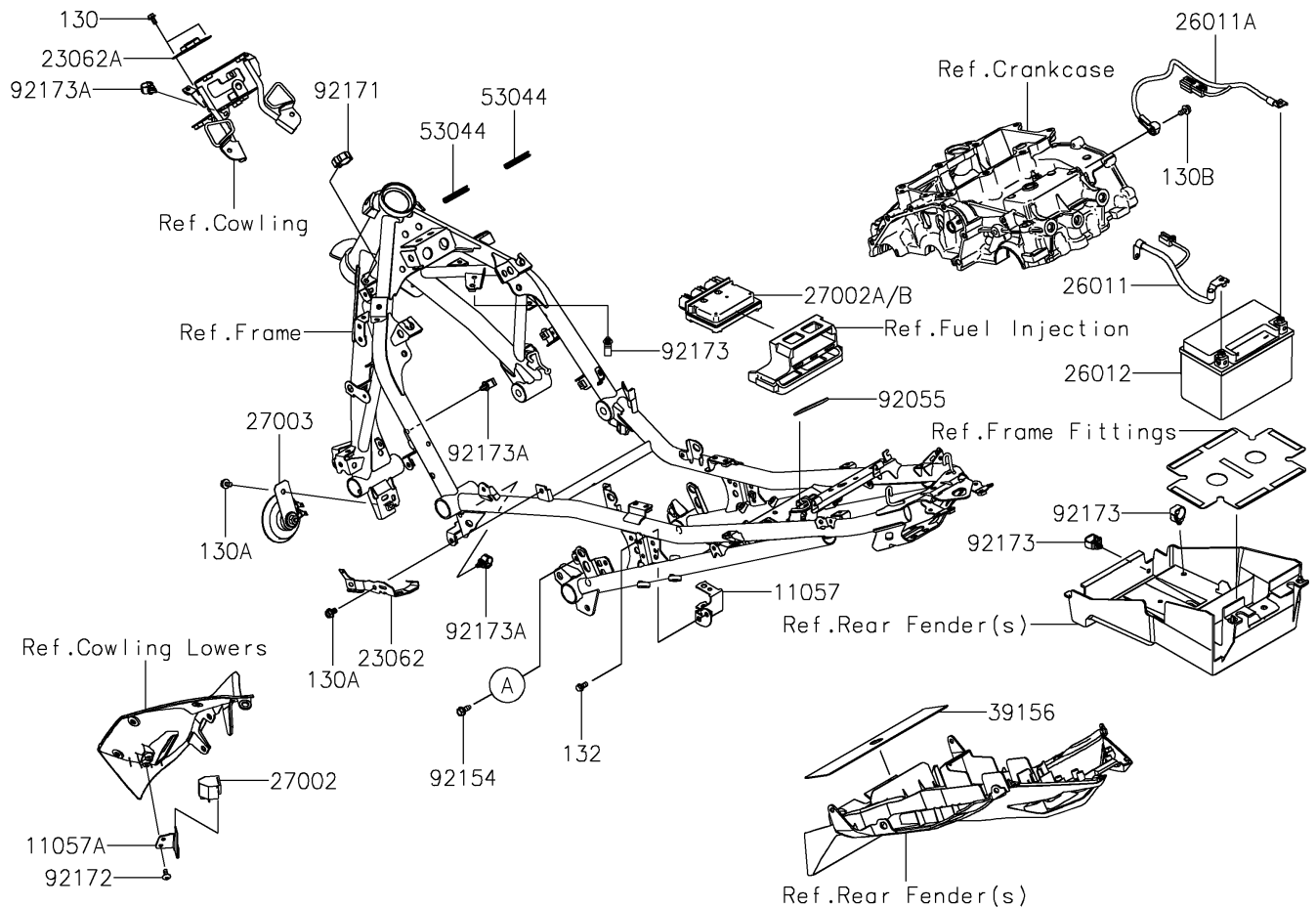
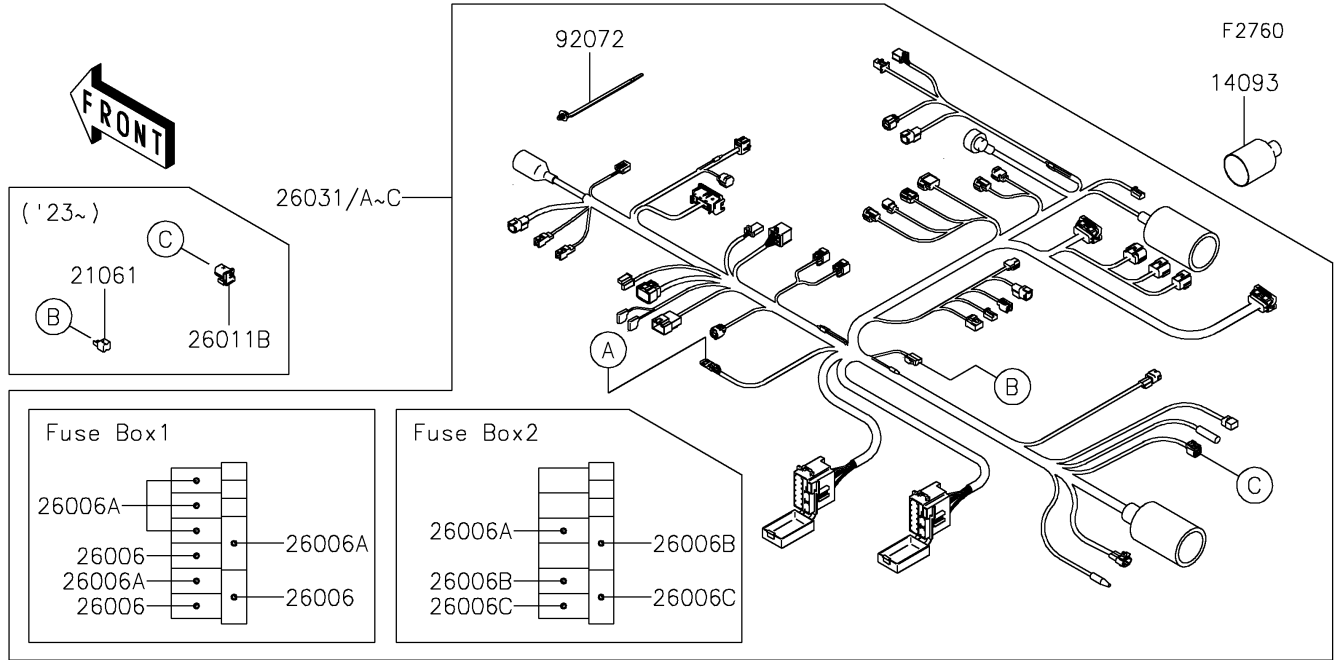

2021 Z400 ABS PARTS LIST

Chassis Electrical Equipment

ITEM NAME	PART NUMBER	QUANTITY
BRACKET,MAGNETIC SW. (Ref # 11057)	11057-1225	1
BRACKET,RELAY (Ref # 11057A)	11057-1763	1
COVER,HARNESS (Ref # 14093)	14093-0720	1
BRACKET-COMP,FUSE BOX (Ref # 23062)	23062-1193	1
BRACKET-COMP,SIGNAL LAMP (Ref # 23062A)	23062-1231	1
FUSE,MINI BLADE,15A,BLUE (Ref # 26006)	26006-0001	3
FUSE,MINI BLADE,10A,RED (Ref # 26006A)	26006-1078	6
FUSE,MINI BLADE,20A,YELLOW (Ref # 26006B)	26006-1079	2
FUSE,MINI BLADE,30A,GREEN (Ref # 26006C)	26006-1080	2
WIRE-LEAD,BATTERY(+) (Ref # 26011)	26011-0974	1
WIRE-LEAD,BATTERY(-) (Ref # 26011A)	26011-0975	1
BATTERY,FTX9-BS,12V 8AH (Ref # 26012)	26012-1436	1
HARNESS,MAIN (Ref # 26031)	26031-2725	1
HARNESS,MAIN (Ref # 26031A)	26031-2726	1
RELAY-ASSY,TURN SIGNAL (Ref # 27002)	27002-0031	1
RELAY-ASSY (Ref # 27002A)	27002-0050	1
HORN (Ref # 27003)	27003-0065	1
PAD,60X250X1 (Ref # 39156)	39156-2219	1
TRIM,45MM (Ref # 53044)	53044-0644	2
RING-O,50MM (Ref # 92055)	92055-0954	1
BAND,OS170-FT7(BLACK) (Ref # 92072)	92072-1414	AR
BOLT,FLANGED,6X16 (Ref # 92154)	92154-0551	1
CLAMP,BRAKE HOSE (Ref # 92171)	92171-0316	1
SCREW,5X12 (Ref # 92172)	92172-0821	2
CLAMP,HOLDER CLIP (Ref # 92173)	92173-0868	3
CLAMP (Ref # 92173A)	92173-1951	3
BOLT-FLANGED,5X10 (Ref # 130)	130BA0510	2
BOLT-FLANGED,6X10 (Ref # 130A)	130BA0610	2
BOLT-FLANGED,6X12 (Ref # 130B)	130BA0612	1

2021 Z400 ABS PARTS LIST

Chassis Electrical Equipment

ITEM NAME	PART NUMBER	QUANTITY
BOLT-FLANGED-SMALL,6X12 (Ref # 132)	132BA0612	1