

1994 Concours PARTS DIAGRAM

Cylinder Head Cover

E1112

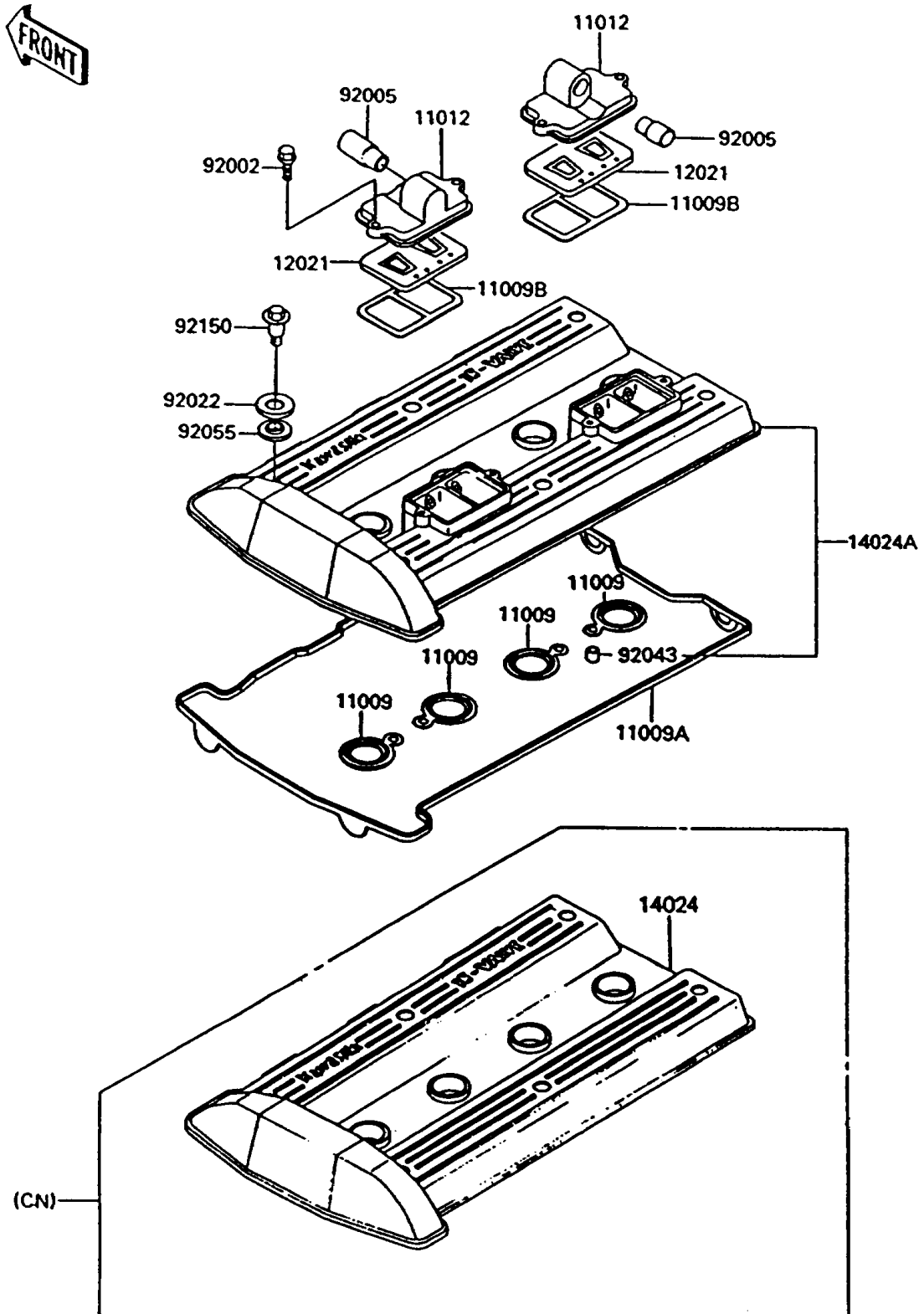

1994 Concours PARTS LIST

Cylinder Head Cover

ITEM NAME	PART NUMBER	QUANTITY
GASKET (Ref # 11009)	11009-1377	4
GASKET,CYLINDER HEAD COVER (Ref # 11009A)	11009-1378	1
GASKET,REED VALVE (Ref # 11009B)	11009-1905	2
CAP,REED VALVE (Ref # 11012)	11012-1481	2
VALVE-ASSY-REED (Ref # 12021)	12021-1053	2
COVER,CYLINDER HEAD (Ref # 14024)	14024-1082	1
COVER,CYLINDER HEAD (Ref # 14024A)	14024-1138	1
BOLT,6X22 (Ref # 92002)	92002-1068	4
FITTING,REED VALVE (Ref # 92005)	92005-1006	2
WASHER,HEAD COVER BOLT (Ref # 92022)	92022-1487	6
PIN,DOWEL,8X10 (Ref # 92043)	92043-1302	4
RING-O,HEAD COVER BOLT (Ref # 92055)	92055-1225	6
BOLT,HEAD COVER (Ref # 92150)	92150-1447	6