

2002 Concours PARTS DIAGRAM

Stand(s)

F2190

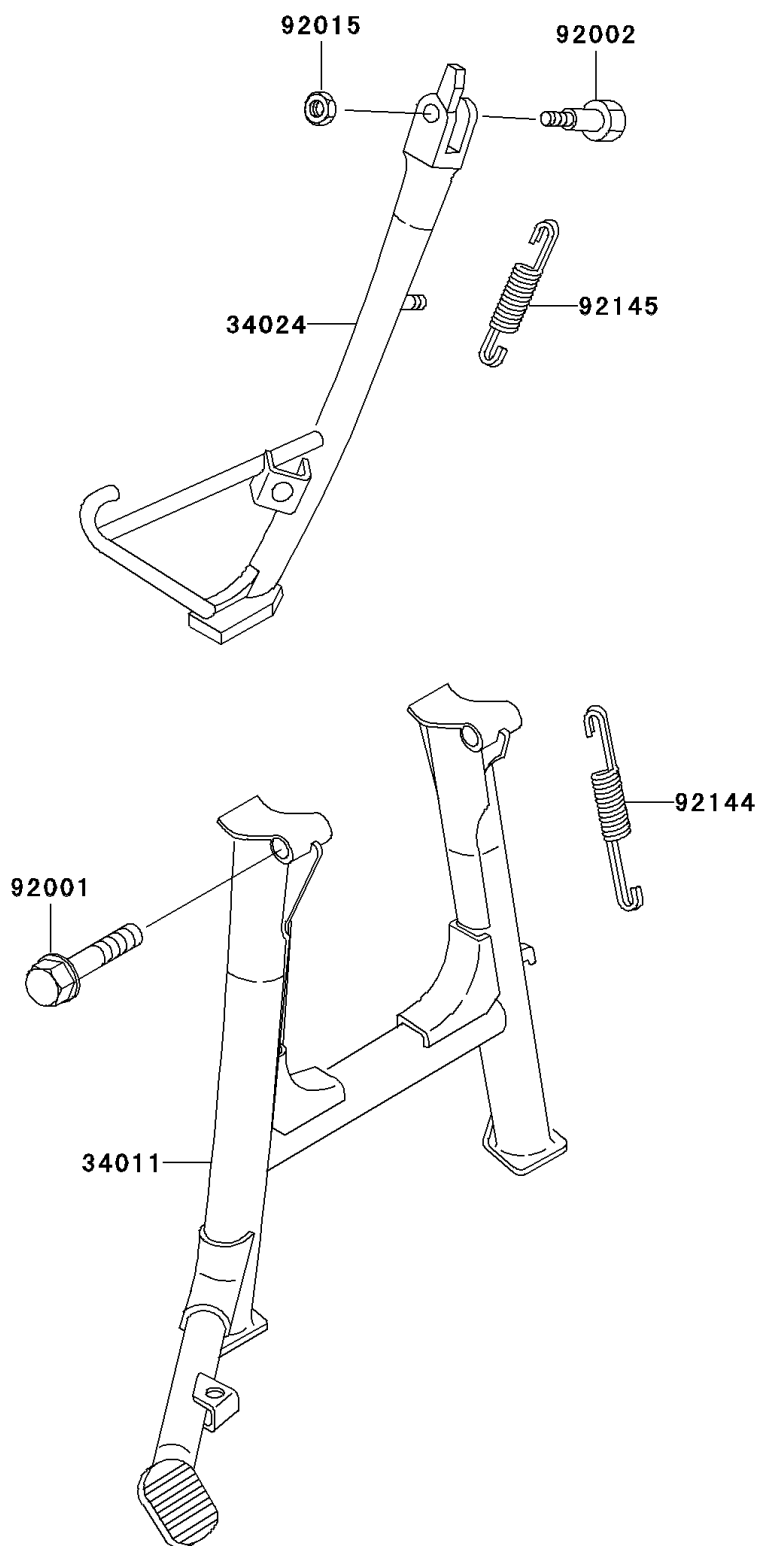

2002 Concours PARTS LIST

Stand(s)

ITEM NAME	PART NUMBER	QUANTITY
STAND-CENTER (Ref # 34011)	34011-1134	1
STAND-SIDE (Ref # 34024)	34024-1208	1
BOLT,CENTER STAND (Ref # 92001)	92001-1880	1
BOLT,SIDE STAND (Ref # 92002)	92002-1813	1
NUT,LOCK,10MM,BLACK (Ref # 92015)	92015-1188	1
SPRING,CENTER STAND (Ref # 92144)	92144-1098	1
SPRING,SIDE STAND (Ref # 92145)	92145-0092	1