

2002 Concours PARTS DIAGRAM

Frame Fittings

F2131

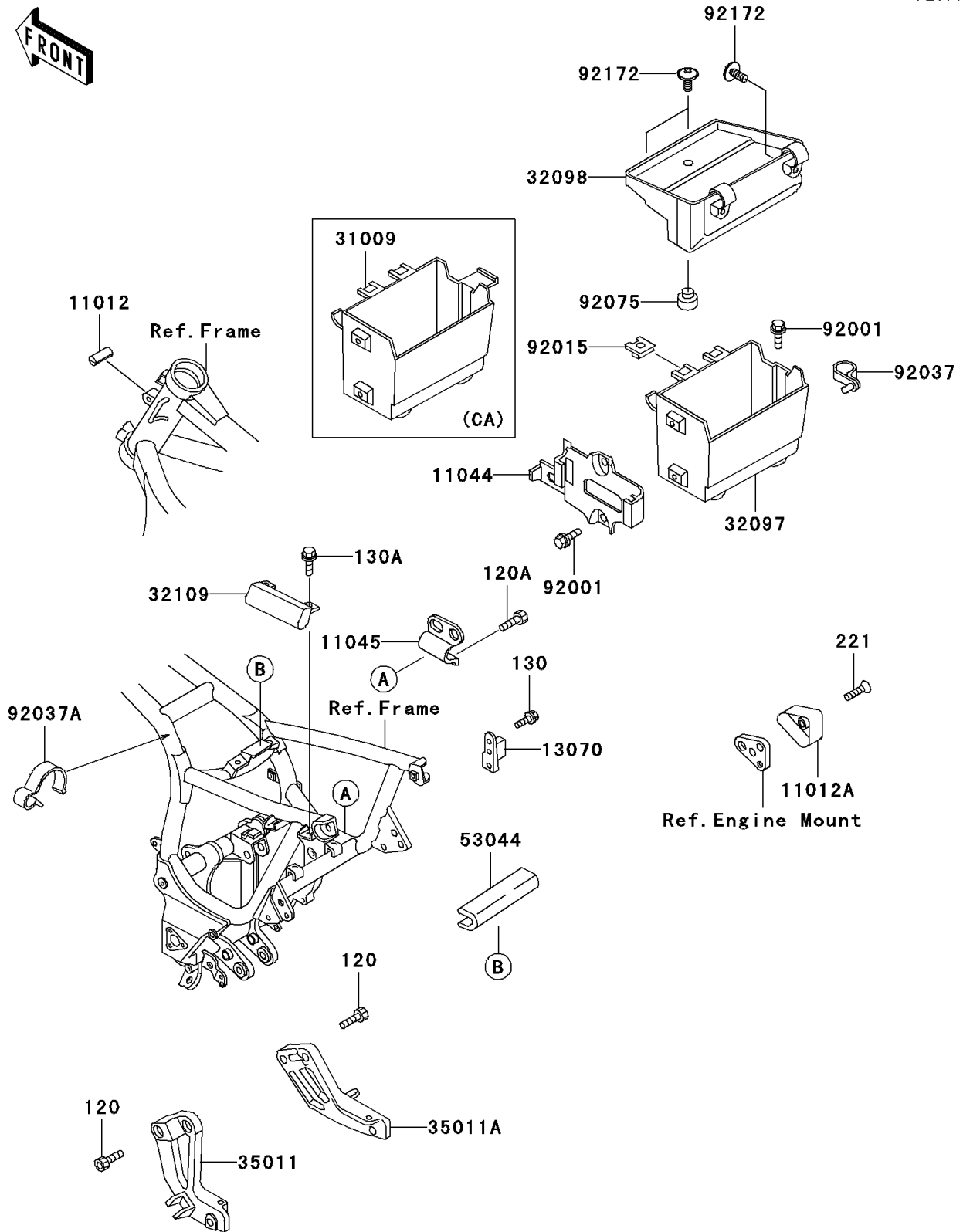

2002 Concours PARTS LIST

Frame Fittings

ITEM NAME	PART NUMBER	QUANTITY
BOLT-SOCKET (Ref # 120)	120P0816	1
BOLT-SOCKET,6X14,BLACK (Ref # 120A)	120S0614	1
BOLT-FLANGED (Ref # 130A)	130J0812	1
SCREW-CSK-CROS (Ref # 221)	221C0620	1
CAP (Ref # 11012)	11012-1438	1
CAP,ENGINE BRACKET (Ref # 11012A)	11012-1531	1
BRACKET,MAGNETIC SWITCH (Ref # 11044)	11044-1642	1
BRACKET,REARSHOCK ADJUST KNOB (Ref # 11045)	11045-1118	1
CASE-TOOL (Ref # 32098)	32098-1068	1
GRIP-FRAME,LH (Ref # 32109)	32109-1136	1
STAY,MUFFLER&REAR STEP,LH (Ref # 35011)	35011-1293	1
STAY,MUFFLER&REAR STEP,RH (Ref # 35011A)	35011-1294	1
TRIM (Ref # 53044)	53044-1174	1
BOLT,6X12 (Ref # 92001)	92001-1771	1
NUT,6MM (Ref # 92015)	92015-1602	1
CLAMP,SPEED,L=43 (Ref # 92037)	92037-1290	1
DAMPER (Ref # 92075)	92075-1045	1
SCREW,6X14 (Ref # 92172)	92172-0004	1
BOLT-FLANGED,6X10,BLACK (Ref # 130)	130C0610	1
GUIDE,HOSE (Ref # 13070)	13070-1160	1
CASE-COMP-BATTERY (Ref # 31009)	31009-1052	1
CASE-BATTERY (Ref # 32097)	32097-1124	1
CLAMP,HOSE (Ref # 92037A)	92037-1552	1