

# 1999 Concours PARTS DIAGRAM

Chassis Electrical Equipment

F2760

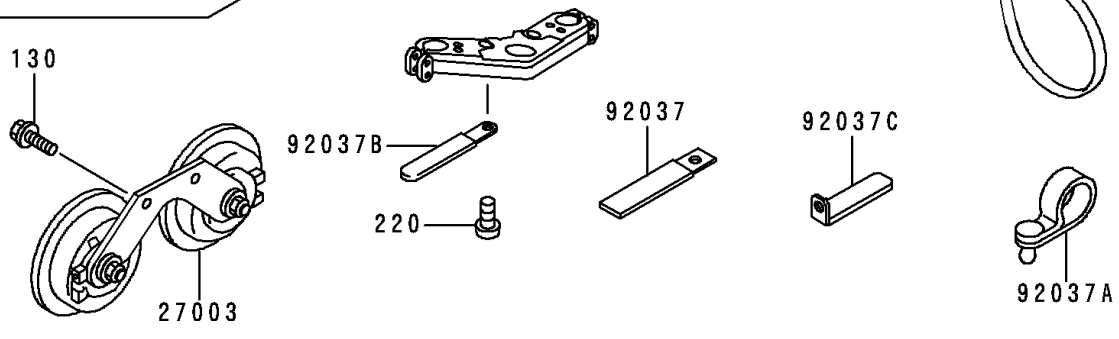
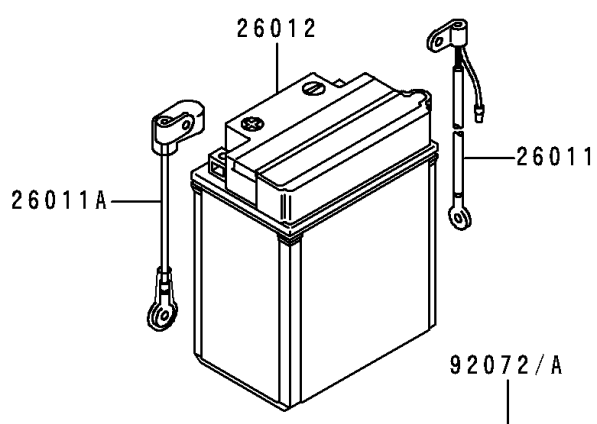
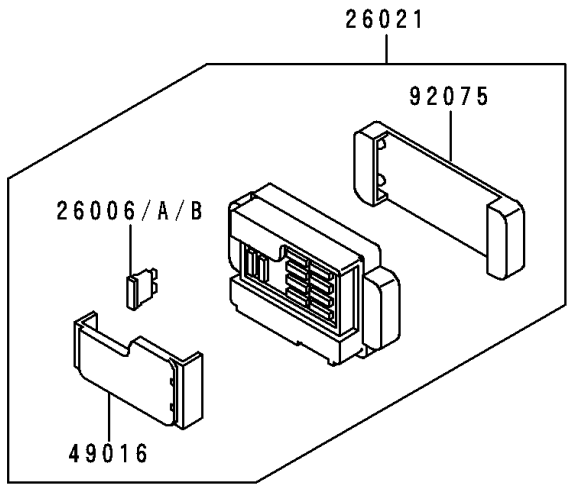
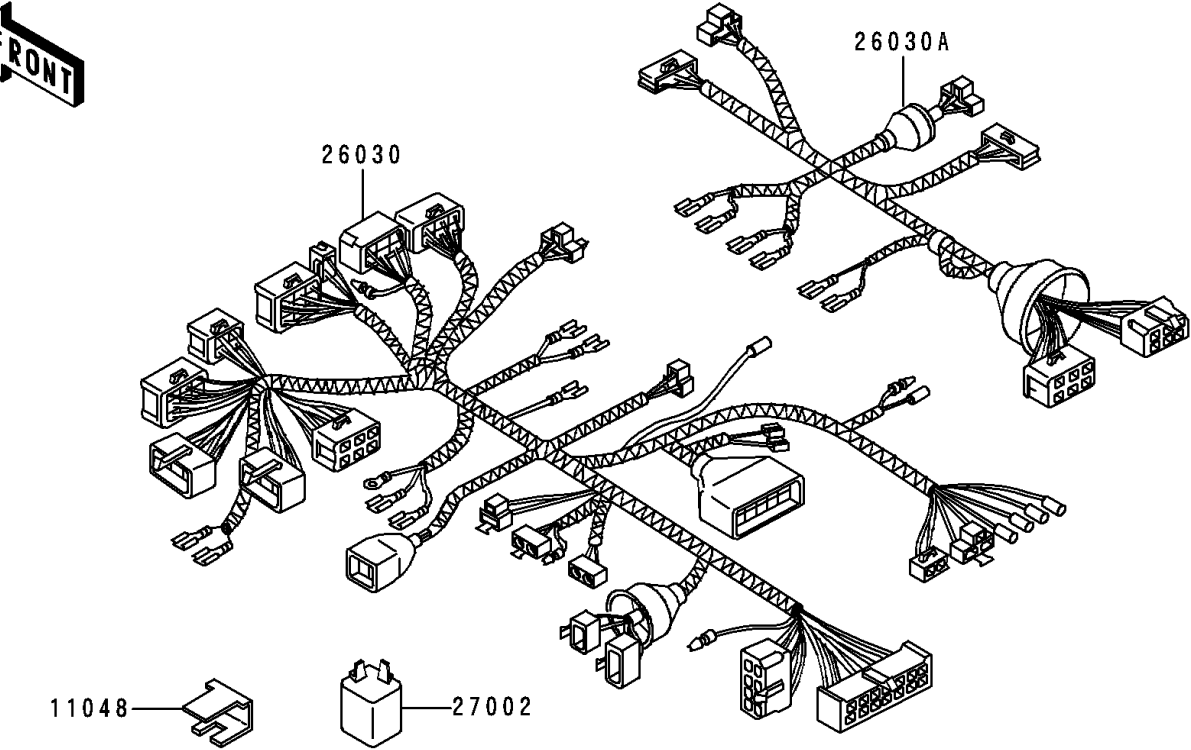

# 1999 Concours PARTS LIST

## Chassis Electrical Equipment

ITEM NAME	PART NUMBER	QUANTITY
BOLT-FLANGED,6X12 (Ref # 130)	130C0612	2
SCREW-PAN-CROS (Ref # 220)	220C0510	1
BRACKET,FUSE LOCK (Ref # 11048)	11048-1680	1
FUSE,30A-G (Ref # 26006)	26006-1067	2
FUSE,10A-R (Ref # 26006A)	26006-1068	6
FUSE,15A-B (Ref # 26006B)	26006-1069	2
WIRE-LEAD,BATTERY(-) (Ref # 26011)	26011-1323	1
WIRE-LEAD,BATTERY(+) (Ref # 26011A)	26011-1358	1
BATTERY,YB18L-A-TP,12V 18AH (Ref # 26012)	26012-1340	1
JUNCTION BOX (Ref # 26021)	26021-1091	1
HARNESS,MAIN (Ref # 26030)	26030-1252	1
HARNESS,COWLING (Ref # 26030A)	26030-1285	1
RELAY-ASSY,TURN SIGNAL (Ref # 27002)	27002-1060	1
HORN,DOUBLE (Ref # 27003)	27003-1372	1
COVER-SEAL,FUSE (Ref # 49016)	49016-1170	1
CLAMP,WIRING HARNESS,L=60 (Ref # 92037)	92037-1069	2
CLAMP,SPEED,L=58 (Ref # 92037A)	92037-1163	2
CLAMP,L=45 (Ref # 92037B)	92037-1539	1
CLAMP,HARNESS (Ref # 92037C)	92037-1564	1
BAND,L=185 (Ref # 92072)	92072-1195	11
BAND,L=365 (Ref # 92072A)	92072-1197	3
DAMPER,JUNCTION BOX (Ref # 92075)	92075-1688	1