

1999 Concours PARTS DIAGRAM

Taillight(s)

F2720

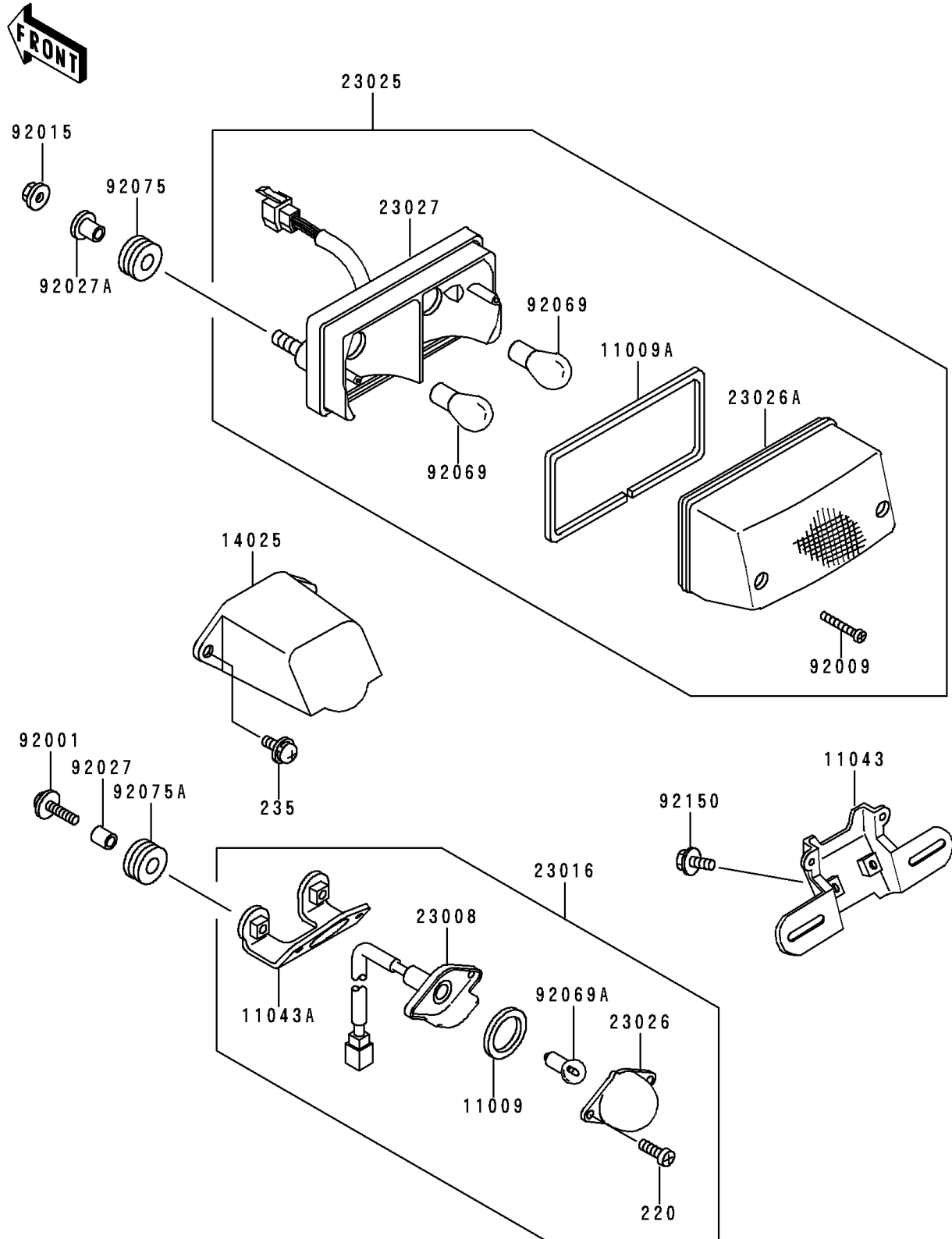

1999 Concours PARTS LIST

Taillight(s)

ITEM NAME	PART NUMBER	QUANTITY
SCREW-PAN-CROS (Ref # 220)	220B0410	2
SCREW-PAN-WP-CROS (Ref # 235)	235C0616	2
GASKET,LICENSE PLATE LAMP (Ref # 11009)	11009-1372	1
GASKET,TAIL LAMP (Ref # 11009A)	11009-1581	1
BRACKET,LICENSE PLATE (Ref # 11043)	11043-1440	1
BRACKET,LICENSE PLATE LAMP (Ref # 11043A)	11043-1497	1
COVER,LICENSE PLATE LAMP (Ref # 14025)	14025-1821	1
SOCKET-ASSY,LICENSE PLATE LAMP (Ref # 23008)	23008-1221	1
LAMP-ASSY,LICENSE PLATE (Ref # 23016)	23016-1053	1
LAMP-TAIL (Ref # 23025)	23025-1139	1
LENS,LAMP (Ref # 23026)	23026-1054	1
LENS,TAIL LAMP (Ref # 23026A)	23026-1079	1
BODY-COMP-TAIL LAMP (Ref # 23027)	23027-1069	1
BOLT,6X20 (Ref # 92001)	92001-1773	2
SCREW,TAPPING,4X20 (Ref # 92009)	92009-1297	2
NUT,FLANGED,6MM (Ref # 92015)	92015-1367	2
COLLAR,6.8X10X10.5 (Ref # 92027)	92027-120	2
COLLAR,L=13.1 (Ref # 92027A)	92027-251	2
BULB,12V 27/8W (Ref # 92069)	92069-059	2
BULB,12V 8W (Ref # 92069A)	92069-1012	1
DAMPER (Ref # 92075)	92075-1690	2
DAMPER,CASE (Ref # 92075A)	92075-222	2
BOLT,6X16 (Ref # 92150)	92150-1909	2