

1998 Concours PARTS DIAGRAM

Handlebar

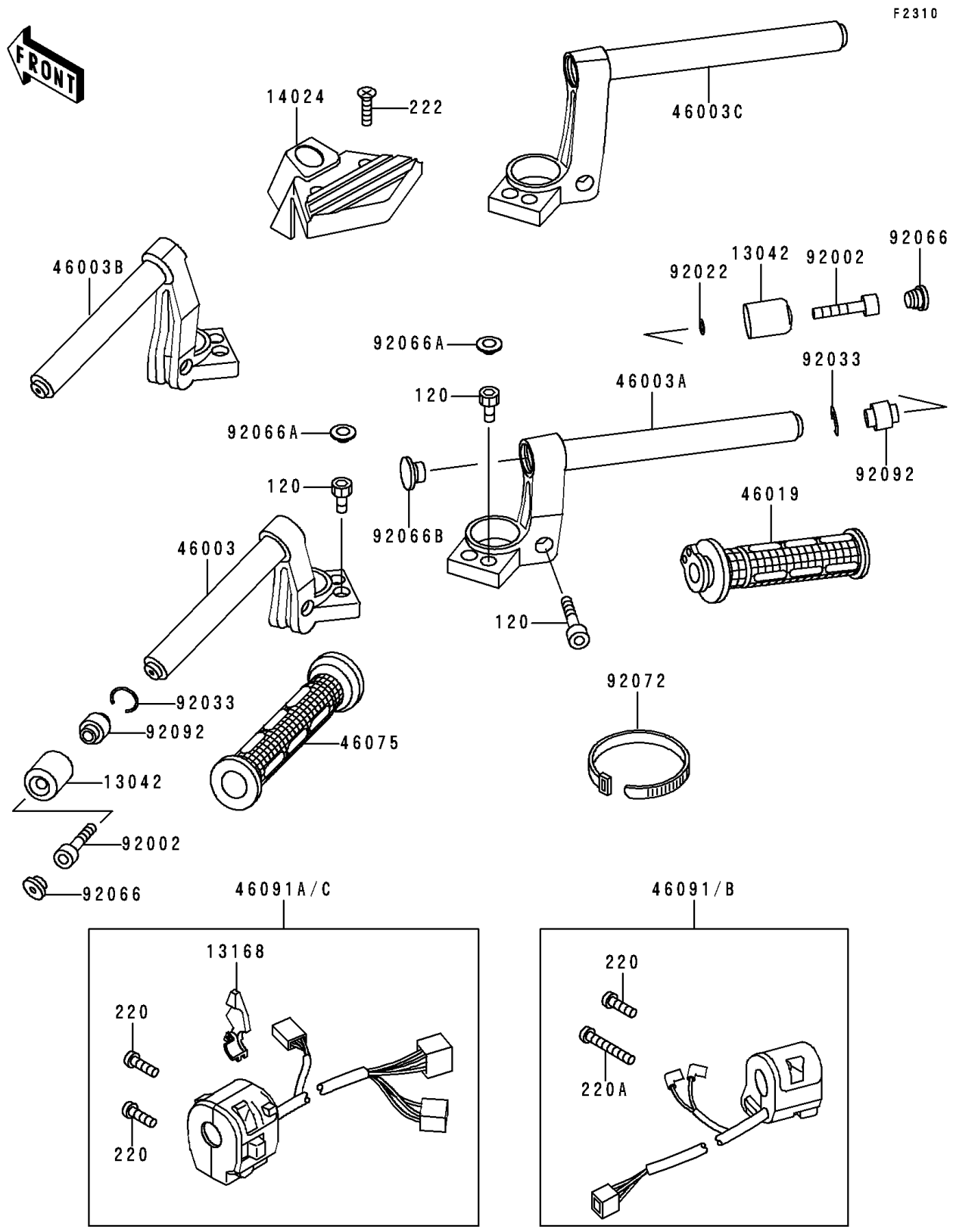

1998 Concours PARTS LIST

Handlebar

ITEM NAME	PART NUMBER	QUANTITY
BOLT-SOCKET,8X20 (Ref # 120)	120S0820	6
SCREW-PAN-CROS (Ref # 220)	220C0525	3
SCREW-PAN-CROS (Ref # 220A)	220C0540	1
SCREW-CSK-RD-CROS (Ref # 222)	222C0525	2
WEIGHT,HANDLE (Ref # 13042)	13042-1006	2
LEVER,CHOKE (Ref # 13168)	13168-1516	1
COVER,HANDLE (Ref # 14024)	14024-1104	1
HANDLE,LH,LOW TYPE (Ref # 46003)	46003-1213	1
HANDLE,RH,LOW TYPE (Ref # 46003A)	46003-1214	1
HANDLE,LH,HIGH TYPE (Ref # 46003B)	46003-1246	1
HANDLE,RH,HIGH TYPE (Ref # 46003C)	46003-1247	1
GRIP-ASSY,THROTTLE (Ref # 46019)	46019-1077	1
GRIP,LH (Ref # 46075)	46075-1088	1
HOUSING-ASSY-CONTROL,RH (Ref # 46091)	46091-1663	1
HOUSING-ASSY-CONTROL,LH (Ref # 46091A)	46091-1665	1
BOLT,SOCKET,8X30 (Ref # 92002)	92002-1844	2
WASHER,8.5X14.5X1.6 (Ref # 92022)	92022-1470	1
RING-SNAP,OD=22.2 (Ref # 92033)	92033-1102	2
PLUG,HANDLE (Ref # 92066)	92066-1124	2
PLUG (Ref # 92066A)	92066-1216	4
PLUG,13.5X12,POLYETHYLENE (Ref # 92066B)	92066-1245	2
BAND,L=365 (Ref # 92072)	92072-1197	2
BUSHING-RUBBER,HANDLE (Ref # 92092)	92092-1018	2