

1998 Concours PARTS DIAGRAM

Oil Cooler

E3034

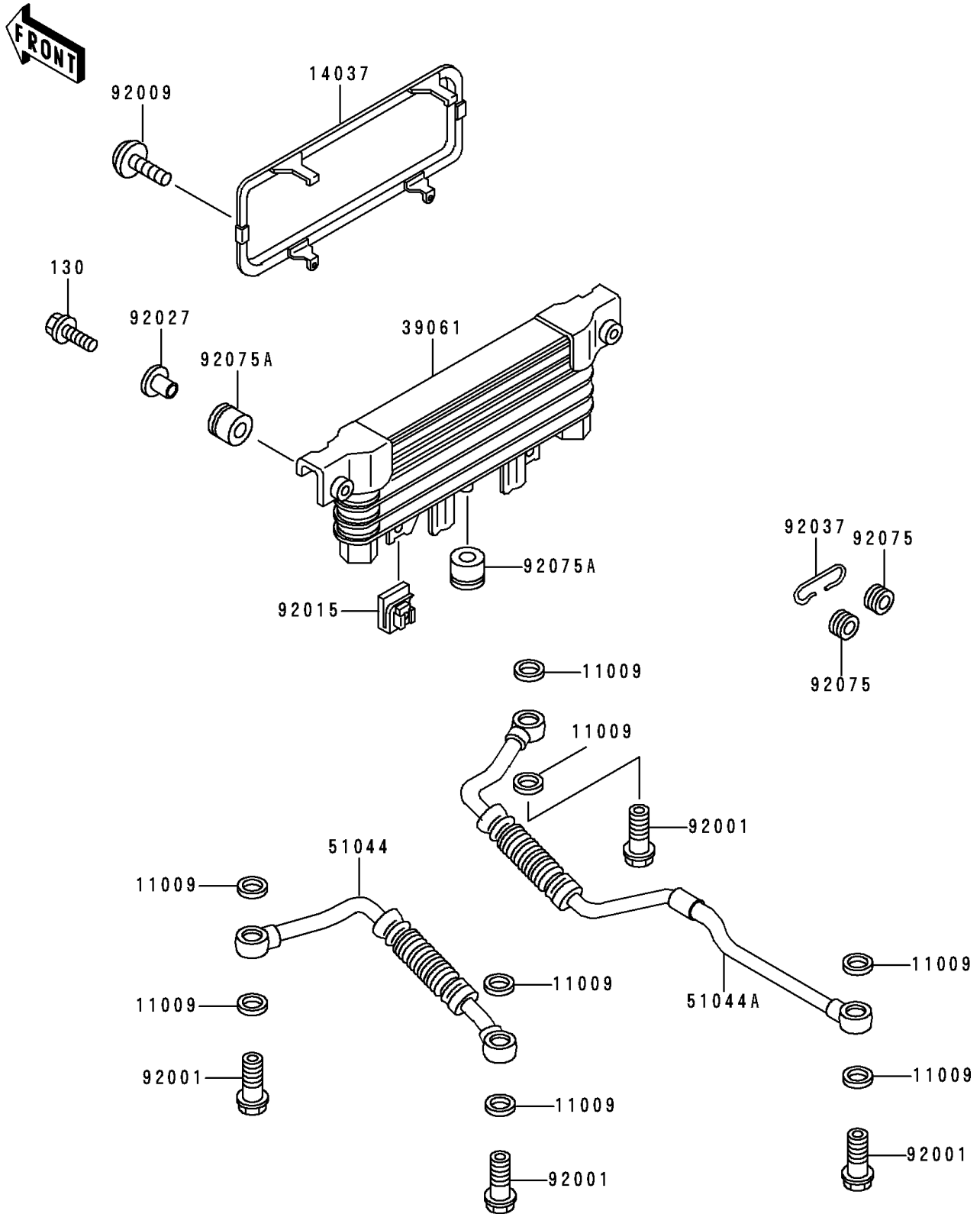

1998 Concours PARTS LIST

Oil Cooler

ITEM NAME	PART NUMBER	QUANTITY
BOLT-FLANGED,6X25 (Ref # 130)	130J0625	3
GASKET,14X19.5X1.4 (Ref # 11009)	11009-1461	8
SCREEN,OIL COOLER (Ref # 14037)	14037-1073	1
OIL COOLER (Ref # 39061)	39061-1117	1
TUBE-ASSY,OIL COOLER,LH (Ref # 51044)	51044-1068	1
TUBE-ASSY,OIL COOLER,RH (Ref # 51044A)	51044-1086	1
BOLT,14X28.5 (Ref # 92001)	92001-1930	4
SCREW,TAPPING,6MM (Ref # 92009)	92009-1261	2
NUT,6MM (Ref # 92015)	92015-1758	2
COLLAR,FLANGED,L=12.1,BLACK (Ref # 92027)	92027-1651	3
CLAMP,OIL COOLER (Ref # 92037)	92037-1905	1
DAMPER,OIL COOLER (Ref # 92075)	92075-1942	2
DAMPER (Ref # 92075A)	92075-277	3