

1999 Concours PARTS DIAGRAM

Carburetor Parts

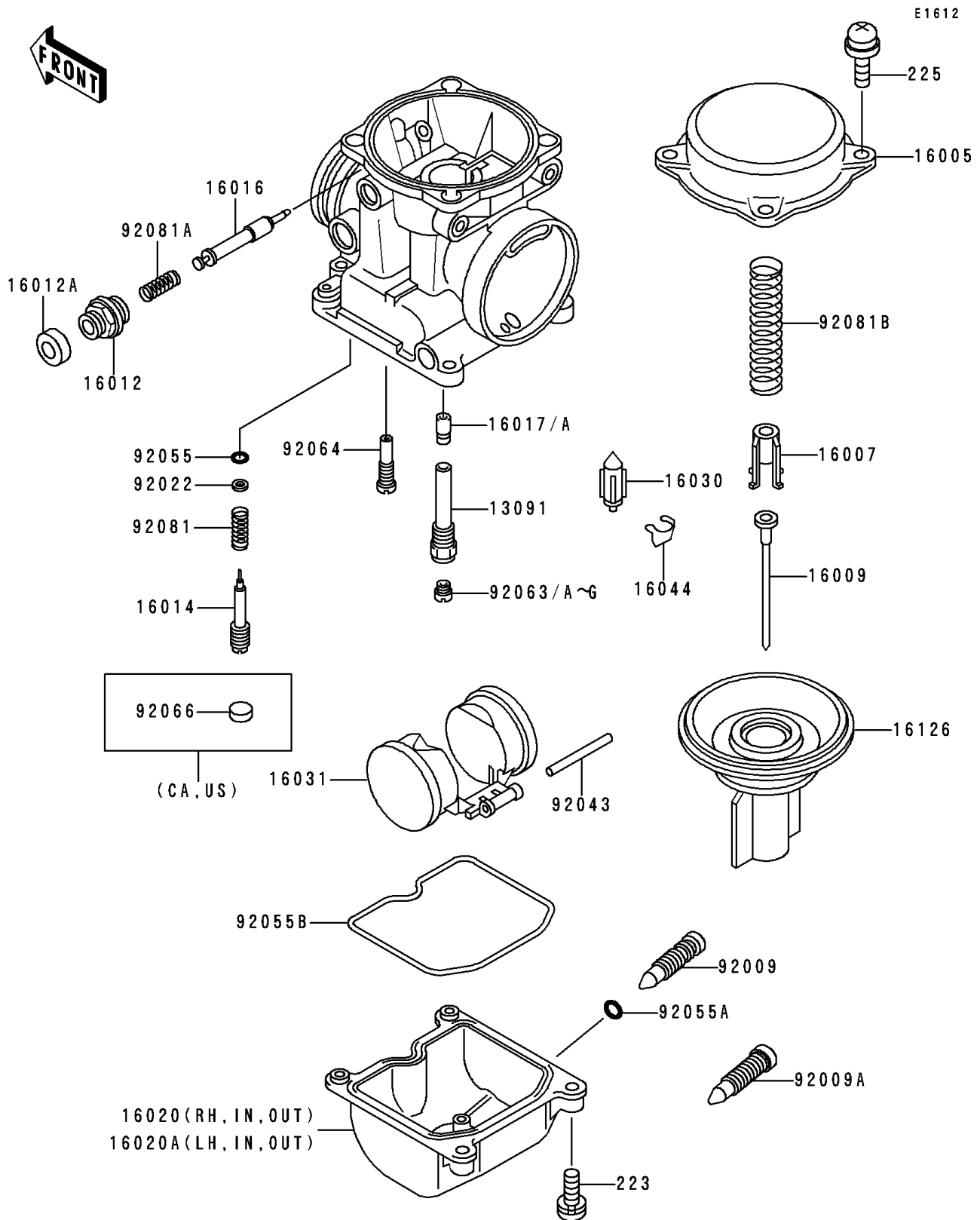

1999 Concours PARTS LIST

Carburetor Parts

ITEM NAME	PART NUMBER	QUANTITY
HOLDER,NEEDLE JET (Ref # 13091)	13091-1259	4
TOP-CHAMBER,MIXING (Ref # 16005)	16005-1056	4
SEAT-SPRING,THROTTLE VALVE (Ref # 16007)	16007-1120	4
NEEDLE-JET,N52M (Ref # 16009)	16009-1326	4
CAP-STARTER PLUNGER (Ref # 16012)	16012-1051	4
CAP-STARTER PLUNGER (Ref # 16012A)	16012-1052	4
SCREW-PILOT AIR (Ref # 16014)	16014-1054	4
PLUNGER,STARTER (Ref # 16016)	16016-1061	4
JET-NEEDLE (Ref # 16017A)	16017-1316	4
VALVE-FLOAT (Ref # 16030)	16030-1007	4
FLOAT (Ref # 16031)	16031-1056	4
CLAMP,FLOAT VALVE (Ref # 16044)	16044-007	4
VALVE,VACUUM (Ref # 16126)	16126-1160	4
SCREW,DRAIN,M6X1.0 (Ref # 92009)	92009-1487	4
SCREW,DRAIN,M6X0.75 (Ref # 92009A)	92009-1551	4
WASHER,PLAIN (Ref # 92022)	92022-1003	4
PIN,FLOAT (Ref # 92043)	92043-1207	4
RING-O,PILOT ADJUST (Ref # 92055)	92055-1002	4
RING-O,DRAIN SCREW (Ref # 92055A)	92055-1053	4
RING-O,FLOAT CHAMBER (Ref # 92055B)	92055-1222	4
JET-MAIN,#125 (Ref # 92063A)	92063-1069	4
JET-MAIN,#128 (Ref # 92063D)	92063-1074	4
SCREW-PAN-WS-CROS (Ref # 223)	223C0416	16
SCREW-PAN-WSP-CROS (Ref # 225)	225C0418	15
JET-PILOT,#35 (Ref # 92064)	92064-1101	4
PLUG,PILOT AIR SCREW,6.9X2 (Ref # 92066)	92066-1051	4
SPRING,PILOT ADJUST SCREW (Ref # 92081)	92081-1002	4
SPRING,STARTER PLUNGER (Ref # 92081A)	92081-1761	4
SPRING,VACUUM VALVE (Ref # 92081B)	92081-1925	4

1999 Concours PARTS LIST

Carburetor Parts

ITEM NAME	PART NUMBER	QUANTITY
CHAMBER-FLOAT,RH,SIDE (Ref # 16020)	16020-1054	2
CHAMBER-FLOAT,LH,SIDE (Ref # 16020A)	16020-1055	2
JET-MAIN,#135 (Ref # 92063)	92063-1014	4
JET-MAIN,#120 (Ref # 92063B)	92063-1072	4
JET-MAIN,#122 (Ref # 92063C)	92063-1073	4
JET-MAIN,#130 (Ref # 92063E)	92063-1075	4
JET-MAIN,#130 (Ref # 92063F)	92063-1075	4
JET-MAIN,#132 (Ref # 92063G)	92063-1076	4