

# 1999 Concours PARTS DIAGRAM

Clutch

E1350

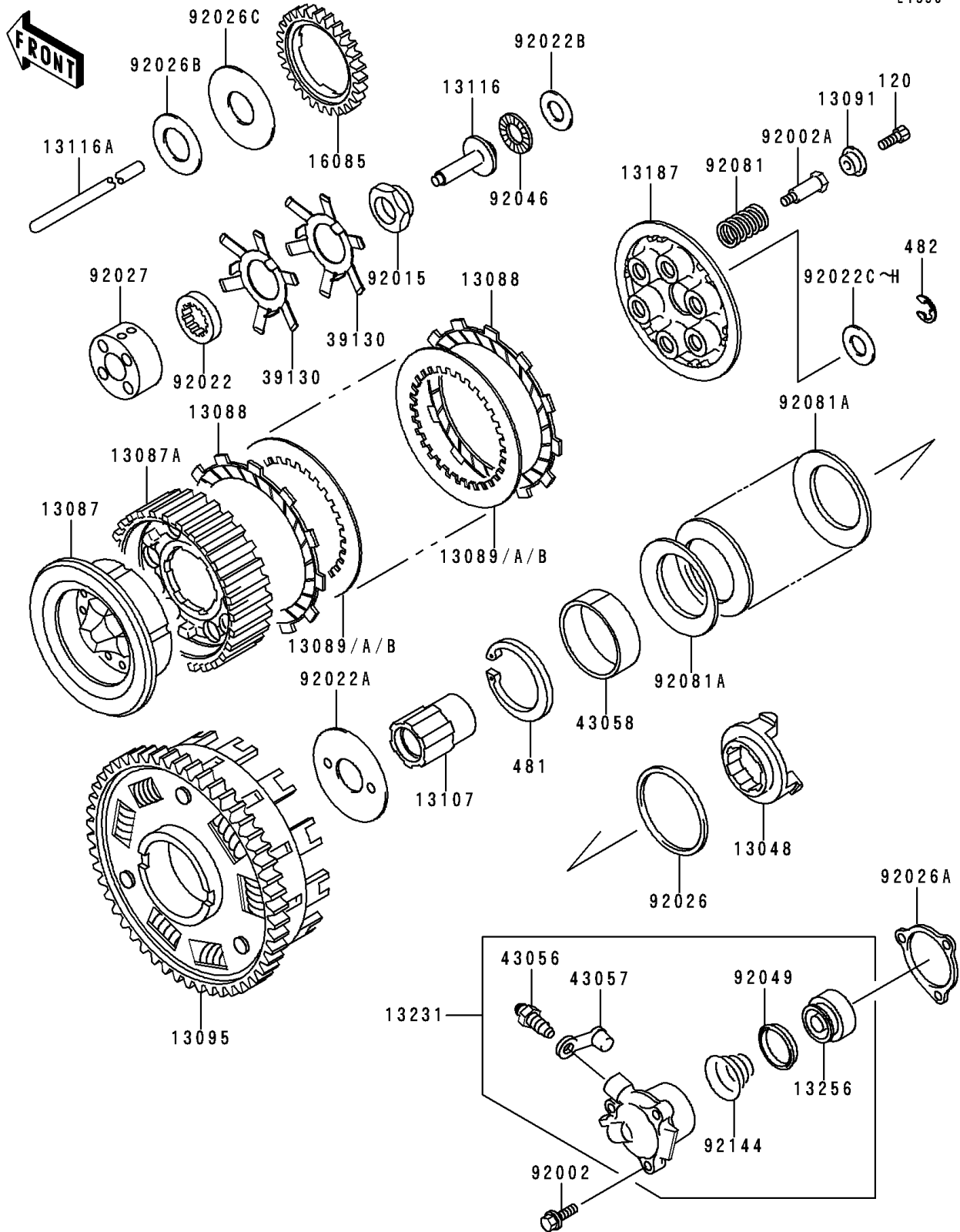

# 1999 Concours PARTS LIST

## Clutch

ITEM NAME	PART NUMBER	QUANTITY
CAM-DAMPER (Ref # 13048)	13048-1007	1
HUB-CLUTCH (Ref # 13087)	13087-1071	1
HUB-CLUTCH (Ref # 13087A)	13087-1072	1
PLATE-FRICTION (Ref # 13088)	13088-1051	9
PLATE-CLUTCH,T=2.3 (Ref # 13089)	13089-1004	AR
PLATE-CLUTCH,T=2.6 (Ref # 13089A)	13089-1067	AR
PLATE-CLUTCH,T=2.0 (Ref # 13089B)	13089-1068	AR
HOLDER,CLUTCH SPRING (Ref # 13091)	13091-1041	6
HOUSING-COMP-CLUTCH (Ref # 13095)	13095-1146	1
SHAFT,CLUTCH (Ref # 13107)	13107-1299	1
ROD-PUSH,CLUTCH (Ref # 13116)	13116-1119	1
ROD-PUSH,CLUTCH (Ref # 13116A)	13116-1140	1
PLATE-CLUTCH OPERATING (Ref # 13187)	13187-1055	1
RELEASE-ASSY-CLUTCH (Ref # 13231)	13231-1072	1
PISTON (Ref # 13256)	13256-1052	1
GEAR,OIL PUMP (Ref # 16085)	16085-1108	1
SPRING-LEAF (Ref # 39130)	39130-1071	2
BREATHER-BRAKE (Ref # 43056)	43056-1052	1
CAP-BREATHER (Ref # 43057)	43057-1001	1
RING (Ref # 43058)	43058-1059	1
BOLT,6X25 (Ref # 92002)	92002-1344	3
BOLT,CLUTCH (Ref # 92002A)	92002-1639	6
NUT (Ref # 92015)	92015-1929	1
WASHER,TOOTHED,25X40X5 (Ref # 92022)	92022-1114	1
WASHER,CLUTCH THRUST (Ref # 92022A)	92022-1221	1
WASHER,15.1X29X1.0 (Ref # 92022B)	92022-1463	1
WASHER,15.1X23X1.0 (Ref # 92022C)	92022-1750	AR
WASHER,15.1X23X0.8 (Ref # 92022D)	92022-1751	AR
WASHER,15.1X23X1.2 (Ref # 92022E)	92022-1752	AR

# 1999 Concours PARTS LIST

## Clutch

ITEM NAME	PART NUMBER	QUANTITY
WASHER,15.1X23X1.4 (Ref # 92022F)	92022-1753	AR
WASHER,15.1X23X1.6 (Ref # 92022G)	92022-1754	AR
WASHER,15.1X23X1.8 (Ref # 92022H)	92022-1755	AR
SPACER,59X70X3.5 (Ref # 92026)	92026-1043	1
SPACER,CLUTCH RELEASE (Ref # 92026A)	92026-1263	1
SPACER,25X45X2.0 (Ref # 92026B)	92026-1306	1
SPACER,25X62X2.0 (Ref # 92026C)	92026-1307	1
COLLAR (Ref # 92027)	92027-1710	1
BEARING-NEEDLE,AXK1102 (Ref # 92046)	92046-1052	1
SEAL-OIL,PISTON (Ref # 92049)	92049-1165	1
SPRING,CLUTCH (Ref # 92081)	92081-1114	6
BOLT-SOCKET,6X16 (Ref # 120)	120Q0616	6
CIRCLIP (Ref # 481)	481J9500	1
CIRCLIP-TYPE-E,12MM (Ref # 482)	482J0200	1
SPRING (Ref # 92081A)	92081-1906	7
SPRING,CLUTCH RELEASE (Ref # 92144)	92144-1084	1