

1998 Concours PARTS DIAGRAM

Crankshaft

E1321

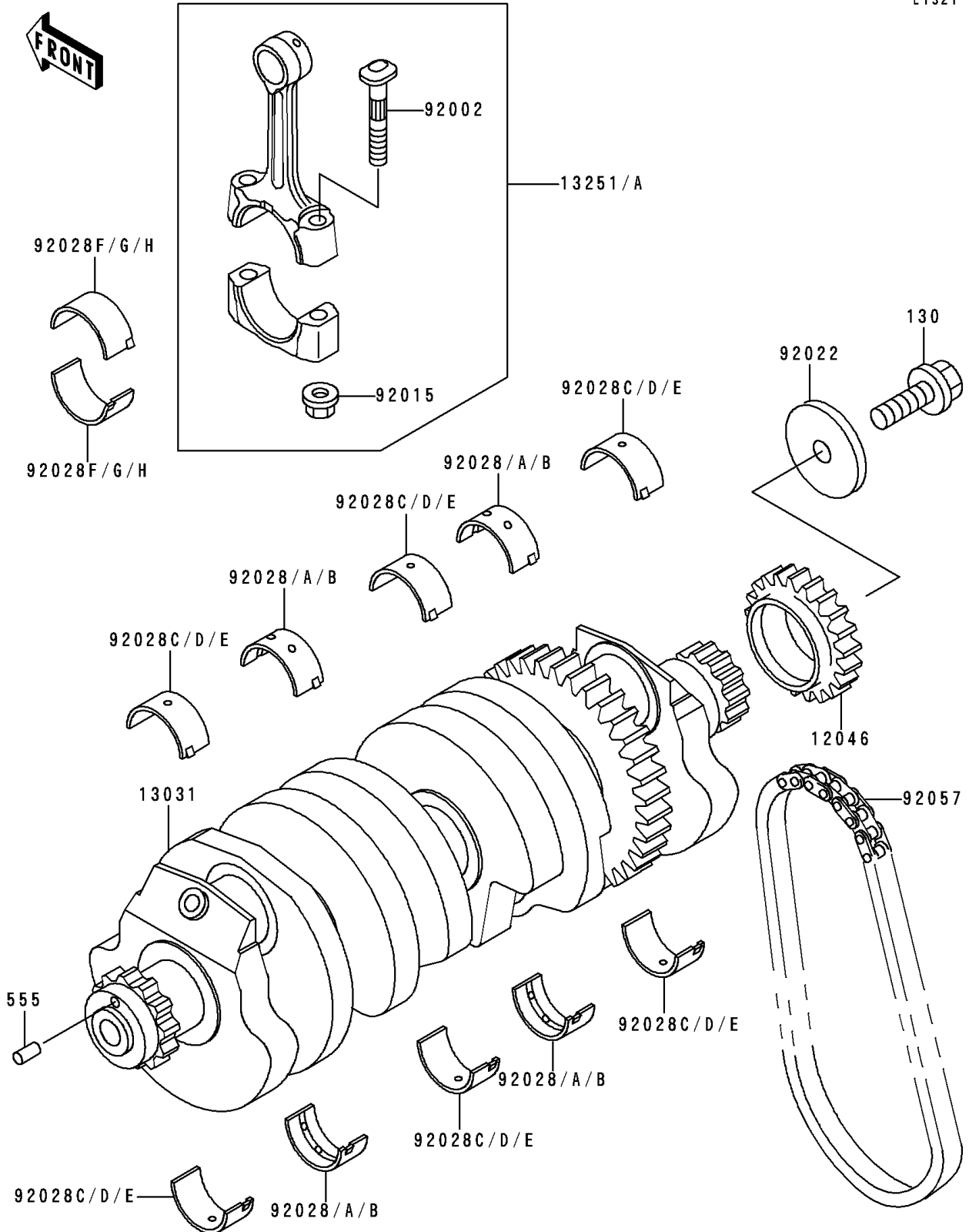

1998 Concours PARTS LIST

Crankshaft

ITEM NAME	PART NUMBER	QUANTITY
BOLT-FLANGED,8X25 (Ref # 130)	130G0825	1
PIN-SPRING (Ref # 555)	555A0412	1
SPROCKET,21T (Ref # 12046)	12046-1084	1
CRANKSHAFT-COMP (Ref # 13031)	13031-1334	1
ROD-ASSY-CONNECTING,K (Ref # 13251)	13251-1075-KK	4
ROD-ASSY-CONNECTING,L (Ref # 13251A)	13251-1075-LL	4
BOLT,CONNECTING ROD,9MM (Ref # 92002)	92002-1678	8
NUT,CONNECTING ROD (Ref # 92015)	92015-1559	8
WASHER,8.5X36X4 (Ref # 92022)	92022-1633	1
BUSHING,CRANKSHAFT,BLUE (Ref # 92028)	92028-1100	AR
BUSHING,CRANKSHAFT,BLACK (Ref # 92028A)	92028-1101	AR
BUSHING,CRANKSHAFT,BROWN (Ref # 92028B)	92028-1102	AR
BUSHING,CRANKSHAFT,BLUE (Ref # 92028C)	92028-1272	AR
BUSHING,CRANKSHAFT,BLACK (Ref # 92028D)	92028-1273	AR
BUSHING,CRANKSHAFT,BROWN (Ref # 92028E)	92028-1274	AR
BUSHING,CONNECTING ROD BLUE (Ref # 92028F)	92028-1407	AR
BUSHING,CONNECTING ROD BLACK (Ref # 92028G)	92028-1408	AR
BUSHING,CONNECTING ROD BROWN (Ref # 92028H)	92028-1409	AR
CHAIN,GENERATOR (Ref # 92057)	92057-1209	1