

1999 Concours PARTS DIAGRAM

Cylinder Head

E1111

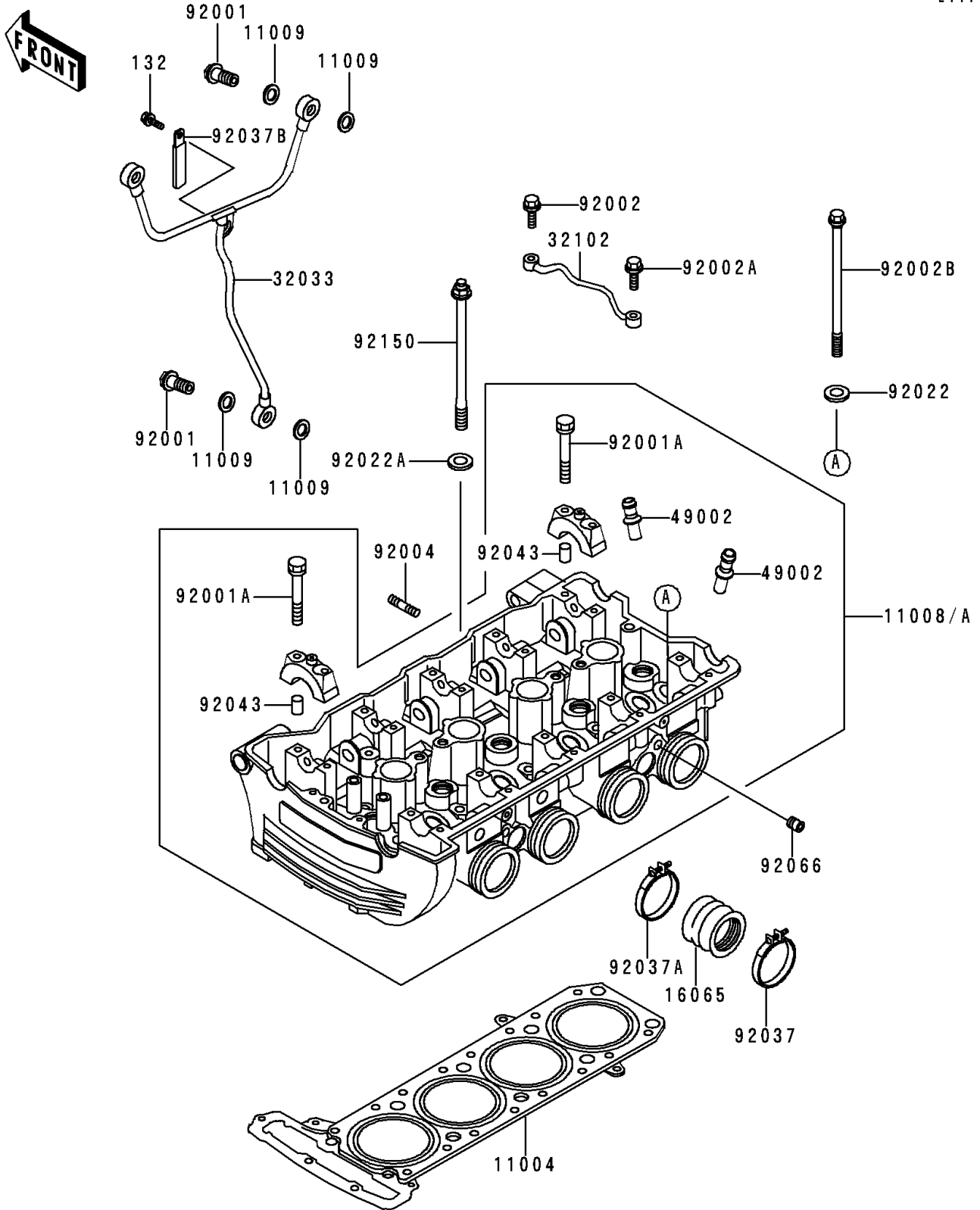

1999 Concours PARTS LIST

Cylinder Head

ITEM NAME	PART NUMBER	QUANTITY
BOLT-FLANGED-SMALL,6X10 (Ref # 132)	132J0610	1
GASKET-HEAD (Ref # 11004)	11004-1148	1
HEAD-COMP-CYLINDER (Ref # 11008)	11008-1177	1
GASKET,12.4X17X1.5 (Ref # 11009)	11009-1376	6
HOLDER-CARBURETOR (Ref # 16065)	16065-1112	4
PIPE,OIL PAN-HEAD (Ref # 32033)	32033-1850	1
PIPE,CYLINDER HEAD (Ref # 32102)	32102-1423	2
GUIDE-VALVE (Ref # 49002)	49002-1052	16
BOLT,BANJO,12X23 (Ref # 92001)	92001-1871	3
BOLT,6X46 (Ref # 92001A)	92001-1872	20
BOLT,6X31.6 (Ref # 92002)	92002-1911	2
BOLT,6X26.6 (Ref # 92002A)	92002-1912	2
BOLT,10X164 (Ref # 92002B)	92002-1943	4
STUD,8X28 (Ref # 92004)	92004-1110	8
WASHER,10.5X20X1.6 (Ref # 92022)	92022-1591	4
WASHER,11.5X20.5X1.6 (Ref # 92022A)	92022-1720	6
CLAMP,ID=53,BLACK (Ref # 92037)	92037-1304	4
CLAMP (Ref # 92037A)	92037-1523	4
PIN,6.2X8X14 (Ref # 92043)	92043-1263	20
PLUG (Ref # 92066)	92066-1201	2
BOLT,11X164 (Ref # 92150)	92150-1075	6