

1986 Concours PARTS DIAGRAM

Meter(s)

F2530-0274

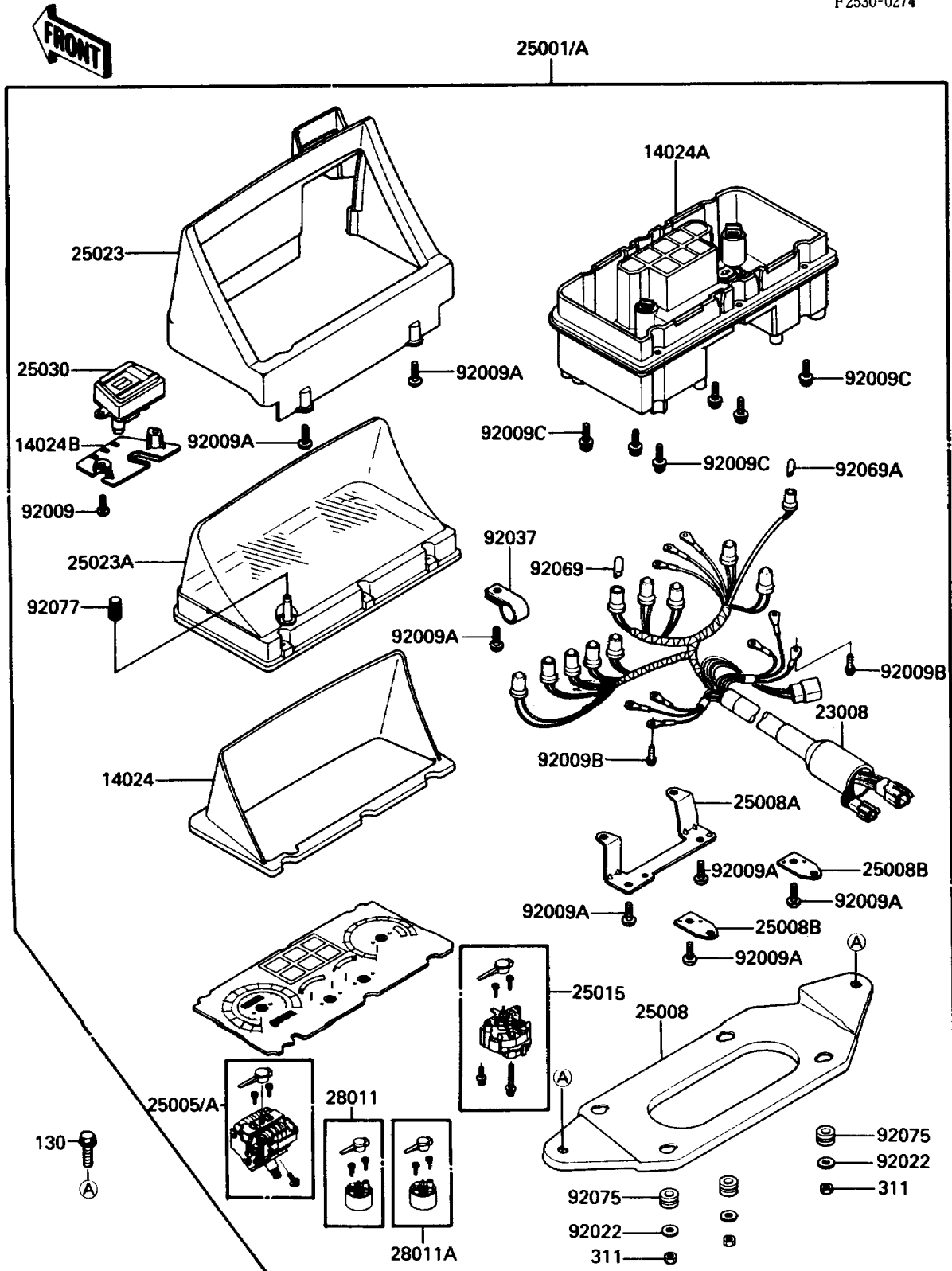

1986 Concours PARTS LIST

Meter(s)

ITEM NAME	PART NUMBER	QUANTITY
COVER,METER,UPP (Ref # 14024)	14024-1179	1
COVER,METER HOUSING (Ref # 14024A)	14024-1338	1
COVER,DEGITAL CLOCK (Ref # 14024B)	14024-1339	1
SOCKET-ASSY,METER (Ref # 23008)	23008-1318	1
METER-ASSY,MPH (Ref # 25001)	25001-1641	1
METER-ASSY,KPH (Ref # 25001A)	25001-1663	1
SPEEDOMETER,MPH (Ref # 25005)	25005-1338	1
SPEEDOMETER,KPH (Ref # 25005A)	25005-1339	1
BRACKET-METER (Ref # 25008)	25008-1131	1
BRACKET-METER,UPP (Ref # 25008A)	25008-1132	1
BRACKET-METER,LWR (Ref # 25008B)	25008-1133	1
TACHOMETER,X1000R/MIN (Ref # 25015)	25015-1262	1
COVER-METER CASE,UPP (Ref # 25023)	25023-1147	1
COVER-METER CASE,UPP (Ref # 25023A)	25023-1149	1
CLOCK,DEGITAL (Ref # 25030)	25030-1001	1
METER,FUEL (Ref # 28011)	28011-1088	1
METER,TEMP (Ref # 28011A)	28011-1089	1
SCREW,TAPPING,4X14,YELLOW (Ref # 92009)	92009-1140	1
SCREW,TAPPING,4X16 (Ref # 92009A)	92009-1163	1
SCREW,3X22 (Ref # 92009B)	92009-1293	1
SCREW,3X10 (Ref # 92009C)	92009-1382	1
WASHER,5.2X16X1.2 (Ref # 92022)	92022-263	1
CLAMP,METER (Ref # 92037)	92037-1818	1
BULB,12V 3.4W (Ref # 92069)	92069-1007	1
BULB,12V3W T-7 (Ref # 92069A)	92069-1020	1
DAMPER (Ref # 92075)	92075-1805	1
KNOB,RESET TRIP (Ref # 92077)	92077-1017	1
BOLT-FLANGED,6X12 (Ref # 130)	130C0612	1
NUT-HEX (Ref # 311)	311B0500	1