

1987 Concours PARTS DIAGRAM

Brake Pedal/Torque Link

F2260-0170

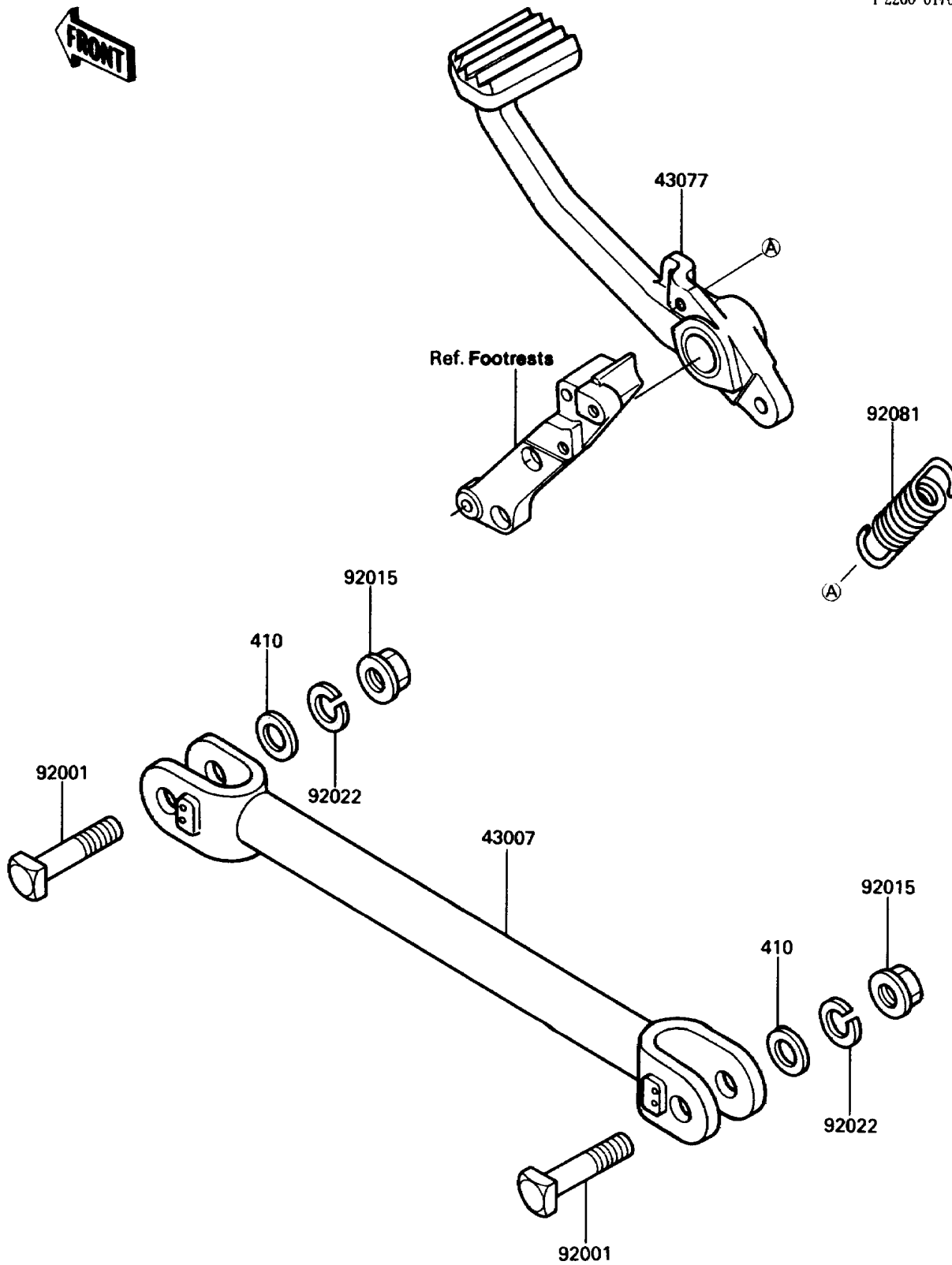

1987 Concours PARTS LIST

Brake Pedal/Torque Link

ITEM NAME	PART NUMBER	QUANTITY
ROD-TORQUE (Ref # 43007)	43007-1130	1
LEVER-ASSY-BRAKE,PEDAL (Ref # 43077)	43077-1062	1
BOLT,10X45 (Ref # 92001)	92001-1208	1
NUT,LOCK,10MM (Ref # 92015)	92015-1429	1
WASHER,SPRING,10MM (Ref # 92022)	92022-1540	1
SPRING,BRAKE PEDAL (Ref # 92081)	92081-1845	1
WASHER-PLAIN-SMALL,10MM (Ref # 410)	410B1000	1