

# 1987 Concours PARTS DIAGRAM

Crankcase Bolt Pattern

E1412-0030

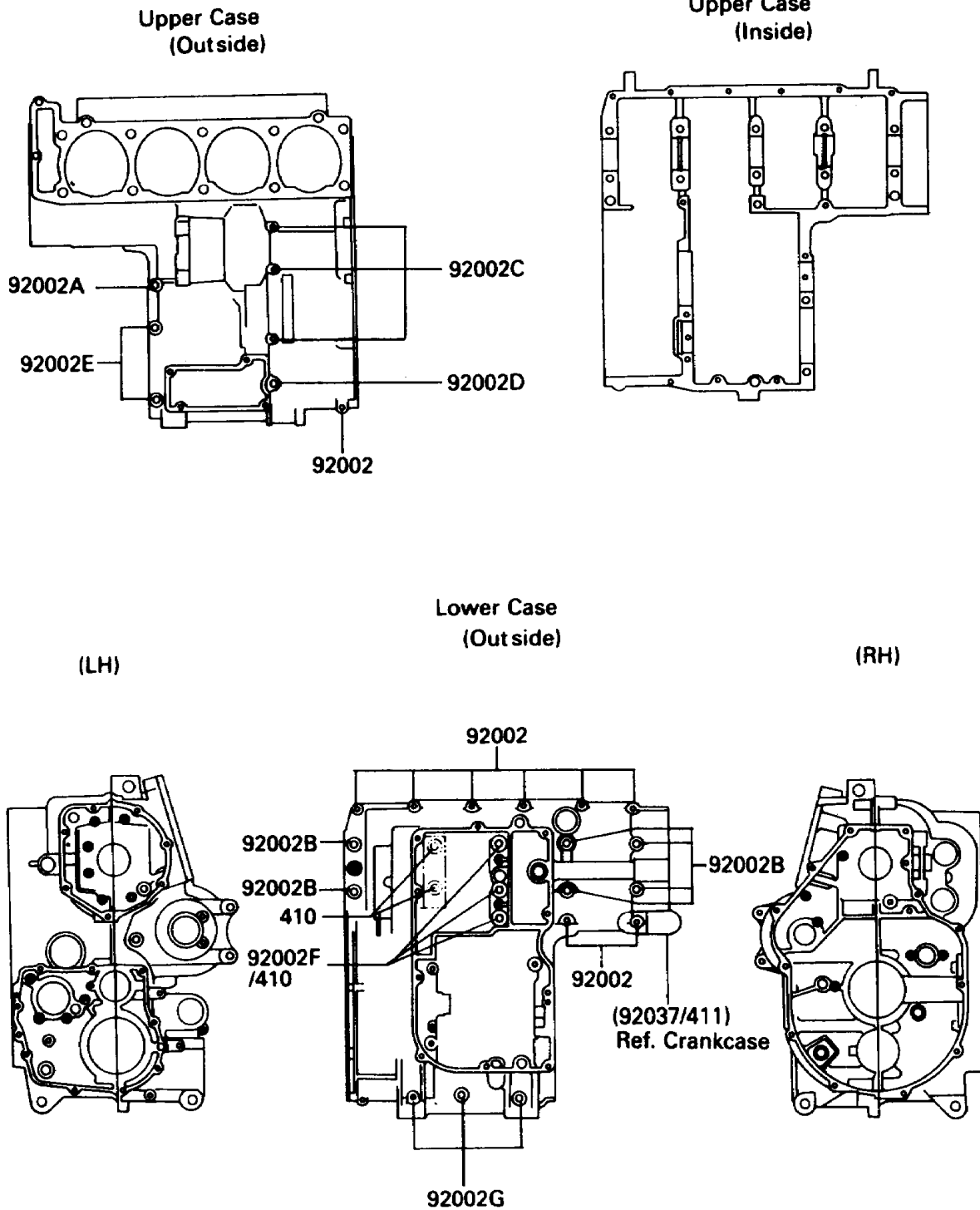

# 1987 Concours PARTS LIST

## Crankcase Bolt Pattern

ITEM NAME	PART NUMBER	QUANTITY
BOLT,6X38 (Ref # 92002)	92001-1899	9
BOLT,6X55 (Ref # 92002A)	92002-1054	1
BOLT,8X90 (Ref # 92002B)	92002-1057	6
BOLT,CONNECTING ROD,7MM (Ref # 92002C)	92150-1081	3
BOLT,6X85 (Ref # 92002D)	92002-1306	1
BOLT,8X63 (Ref # 92002E)	92002-1308	2
BOLT,8X140 (Ref # 92002F)	92002-1402	3
BOLT,6X120 (Ref # 92002G)	92002-1654	3
WASHER-PLAIN-SMALL,8MM (Ref # 410)	410B0800	5