

2002 Vulcan 800 Classic PARTS DIAGRAM

Ignition System

E1830

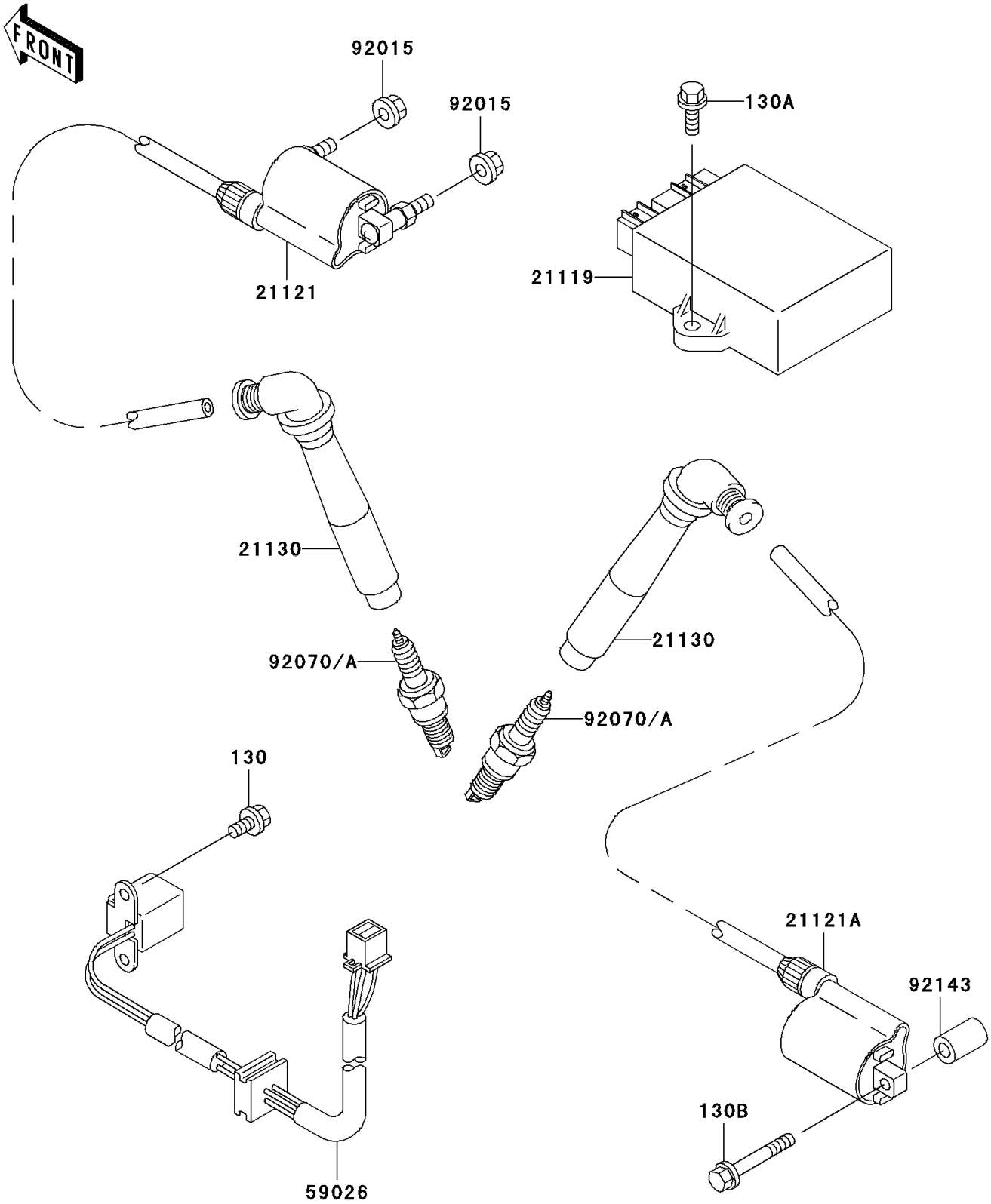

2002 Vulcan 800 Classic PARTS LIST

Ignition System

ITEM NAME	PART NUMBER	QUANTITY
BOLT-FLANGED (Ref # 130)	130G0510	2
BOLT-FLANGED,6X14 (Ref # 130A)	130G0614	2
BOLT-FLANGED (Ref # 130B)	130V0640	2
IGNITER (Ref # 21119)	21119-1438	1
COIL-IGNITION,FR (Ref # 21121)	21121-1245	1
COIL-IGNITION,RR (Ref # 21121A)	21121-1246	1
CAP-SPARK PLUG (Ref # 21130)	21130-1075	2
COIL-PULSING (Ref # 59026)	59026-1130	1
NUT,FLANGED,6MM (Ref # 92015)	92015-1367	2
PLUG-SPARK,CR8E(NGK) (Ref # 92070)	92070-1169	AR
PLUG-SPARK,CR7E(NGK) (Ref # 92070A)	92070-1209	2
COLLAR,6.8X13X20 (Ref # 92143)	92143-1773	2