

# 1997 Vulcan 800 Classic PARTS DIAGRAM

Ignition Switch/Locks/Reflectors

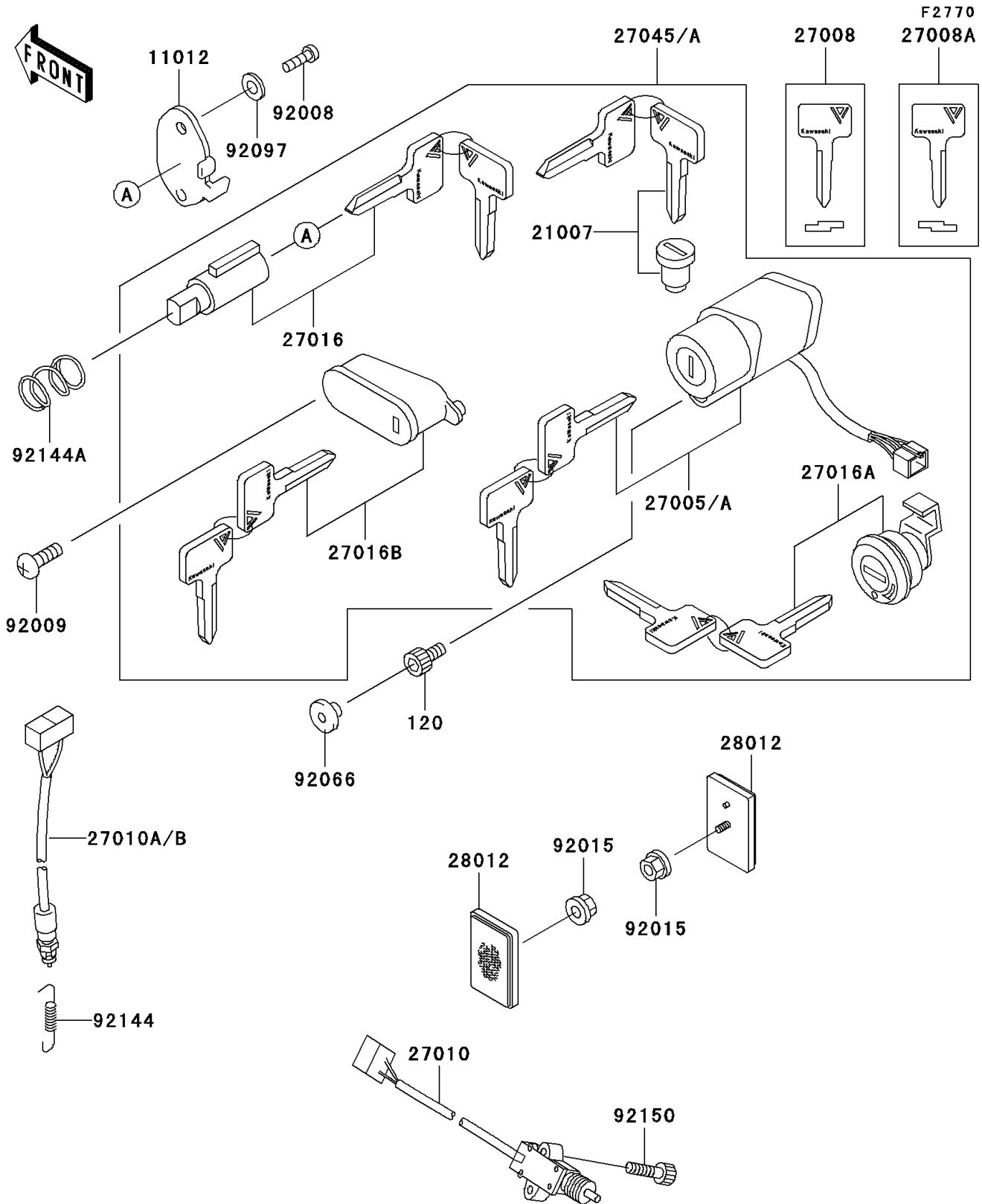

# 1997 Vulcan 800 Classic PARTS LIST

Ignition Switch/Locks/Reflectors

ITEM NAME	PART NUMBER	QUANTITY
-----------	-------------	----------