

# 1996 Vulcan 800 Classic PARTS DIAGRAM

Left Engine Cover(s)

E1435

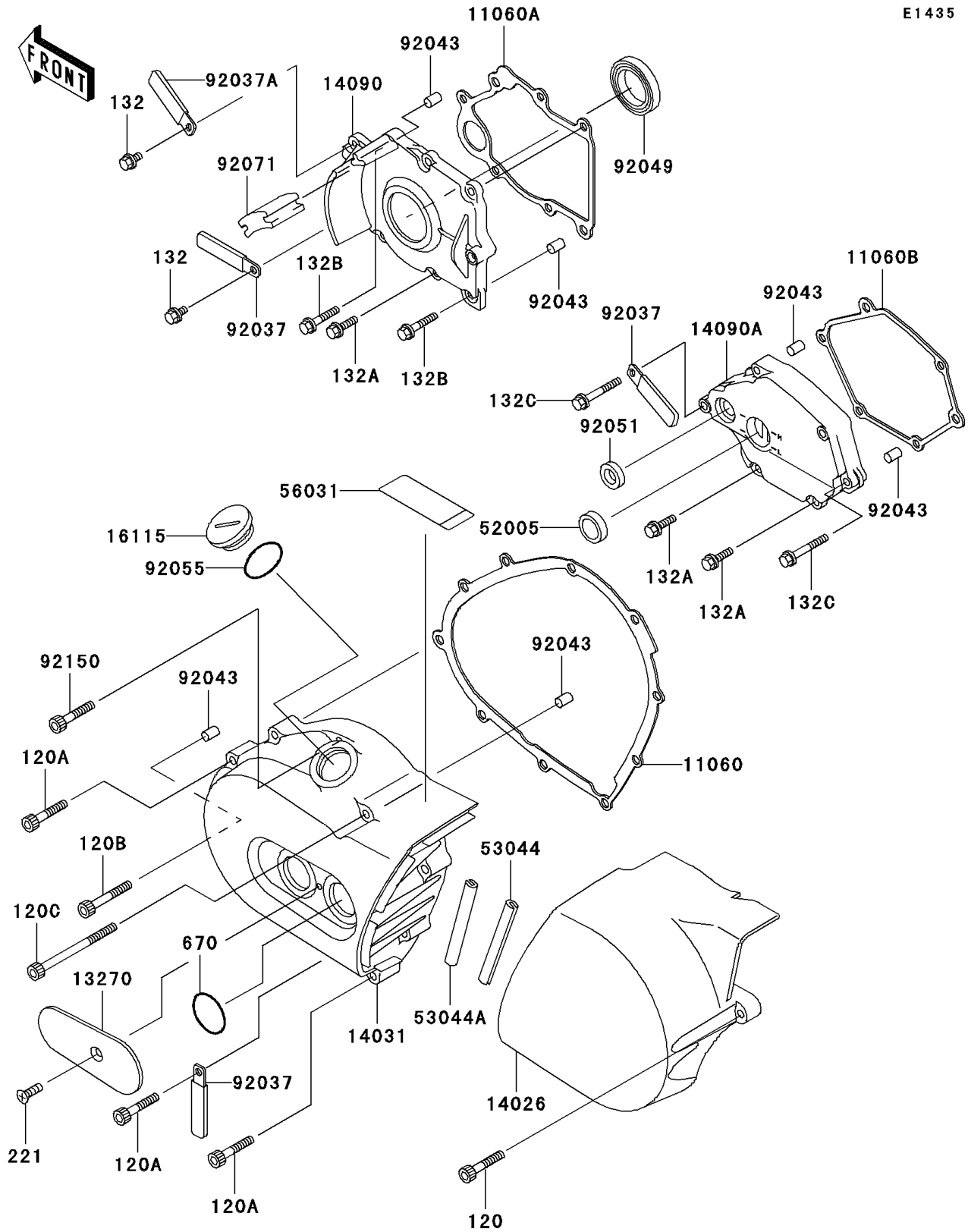

# 1996 Vulcan 800 Classic PARTS LIST

## Left Engine Cover(s)

ITEM NAME	PART NUMBER	QUANTITY
BOLT-SOCKET (Ref # 120)	120R0630	1
BOLT-SOCKET (Ref # 120A)	120R0635	7
BOLT-SOCKET (Ref # 120B)	120R0645	1
BOLT-SOCKET (Ref # 120C)	120R0685	1
BOLT-FLANGED-SMALL,6X10 (Ref # 132)	132H0610	2
BOLT-FLANGED-SMALL (Ref # 132A)	132J0620	7
BOLT-FLANGED-SMALL (Ref # 132B)	132J0630	2
BOLT-FLANGED-SMALL,6X40 (Ref # 132C)	132J0640	4
SCREW-CSK-CROS,6X14 (Ref # 221)	221R0614	1
O RING (Ref # 670)	670B3034	2
GASKET,GENERATOR COVER (Ref # 11060)	11060-1089	1
GASKET,TRANSMISSION COVER (Ref # 11060A)	11060-1683	1
GASKET,MECHANISM COVER (Ref # 11060B)	11060-1685	1
PLATE (Ref # 13270)	13270-1397	1
COVER-CHAIN (Ref # 14026)	14026-1217	1
COVER-GENERATOR (Ref # 14031)	14031-1308	1
COVER,TRANSMISSION (Ref # 14090)	14090-1552	1
COVER,MECHANISM (Ref # 14090A)	14090-1559	1
CAP-OIL FILLER (Ref # 16115)	16115-1063	1
GAUGE,OIL LEVEL (Ref # 52005)	52005-1009	1
TRIM (Ref # 53044)	53044-1285	1
TRIM (Ref # 53044A)	53044-1286	1
LABEL-MANUAL,OIL CAPACITY (Ref # 56031)	56031-1894	1
CLAMP,L=45 (Ref # 92037)	92037-1539	3
CLAMP (Ref # 92037A)	92037-1993	1
PIN,6.2X8X14 (Ref # 92043)	92043-1263	6
SEAL-OIL,TC32488 (Ref # 92049)	92049-1361	1
SEAL-OIL,TB13225.5 (Ref # 92051)	92051-005	1
RING-O,31.7X2.4 (Ref # 92055)	92055-049	1

# 1996 Vulcan 800 Classic PARTS LIST

Left Engine Cover(s)

ITEM NAME	PART NUMBER	QUANTITY
GROMMET (Ref # 92071)	92071-1232	1
BOLT,SOCKET,6X35 (Ref # 92150)	92150-1887	1