

2001 Vulcan 800 PARTS DIAGRAM

Headlight(s)(VN800-A7-A9)

F2710A

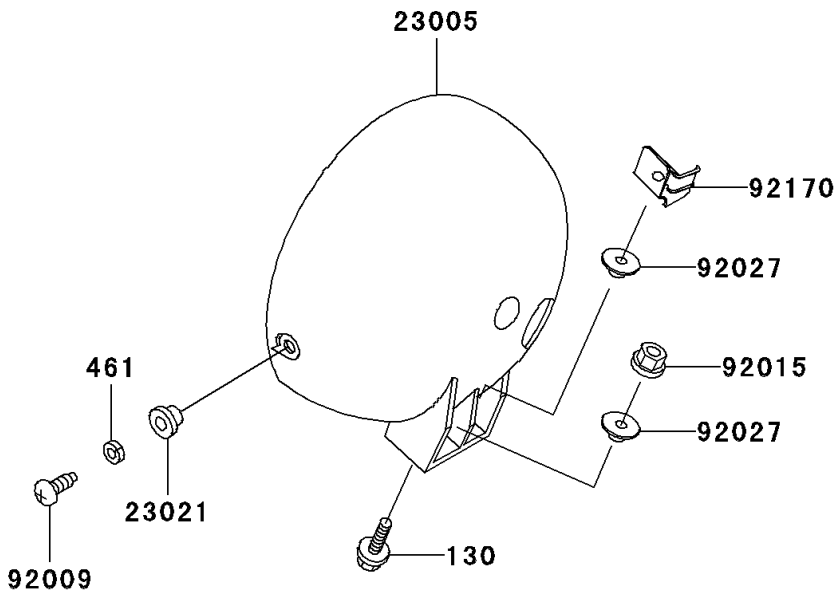
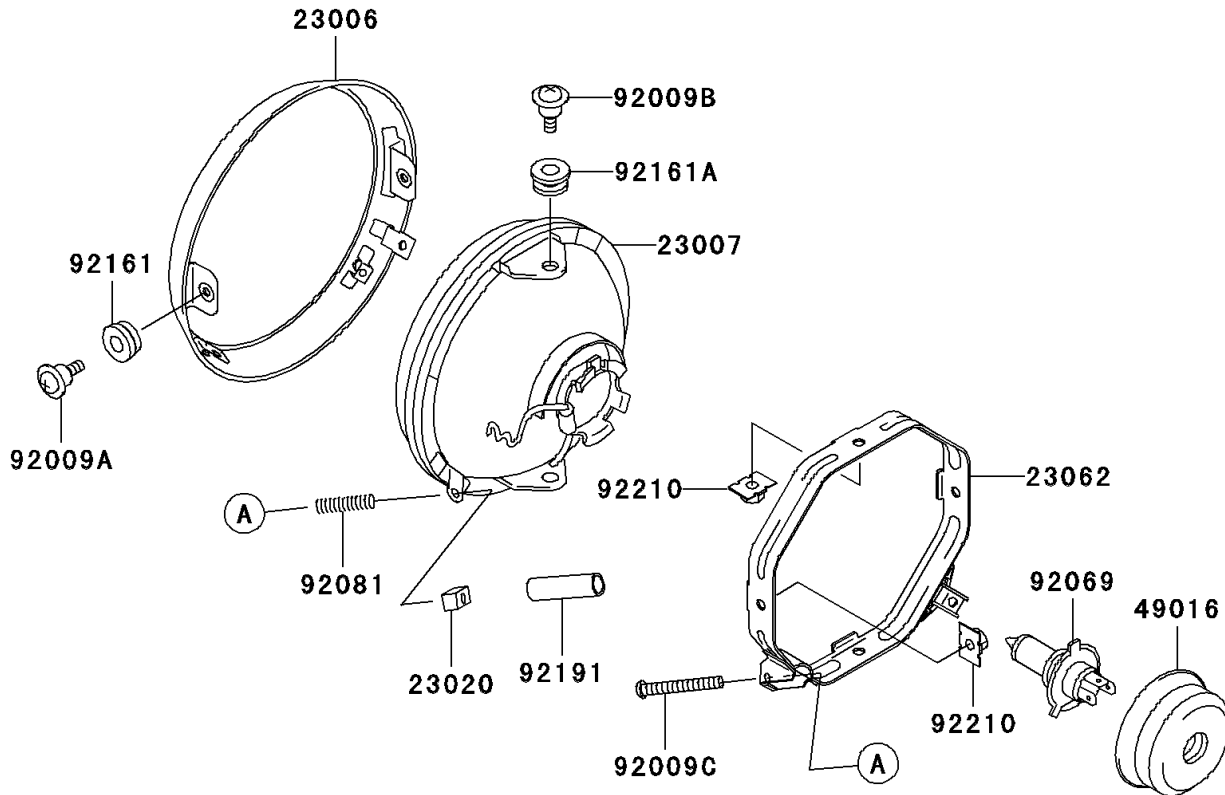

2001 Vulcan 800 PARTS LIST

Headlight(s)(VN800-A7-A9)

ITEM NAME	PART NUMBER	QUANTITY
BOLT-FLANGED (Ref # 130)	130V0620	2
WASHER-SPRING,5MM (Ref # 461)	461F0500	2
BODY-COMP-HEAD LAMP (Ref # 23005)	23005-1149	1
RIM-LAMP (Ref # 23006)	23006-1084	1
LENS-COMP,HEAD LAMP (Ref # 23007)	23007-1401	1
NUT,4MM,FOCUS ADJUST (Ref # 23020)	23020-018	2
WASHER (Ref # 23021)	23021-010	2
BRACKET-COMP (Ref # 23062)	23062-1134	1
COVER-SEAL,HEAD LAMP SOCKET (Ref # 49016)	49016-1210	1
SCREW,5MM (Ref # 92009)	92009-1947	2
SCREW,5MM (Ref # 92009A)	92009-1955	2
SCREW,5MM (Ref # 92009B)	92009-1956	2
SCREW,4X50 (Ref # 92009C)	92009-1957	2
NUT,FLANGED,6MM (Ref # 92015)	92015-1367	1
COLLAR,L=6.5 (Ref # 92027)	92027-252	2
BULB,12V 60/55W,H4 (Ref # 92069)	92069-1002	1
SPRING,FOCUS ADJUSTING (Ref # 92081)	92081-1701	2
DAMPER (Ref # 92161)	92161-1187	2
DAMPER (Ref # 92161A)	92161-1188	2
CLAMP,HARNESS (Ref # 92170)	92170-1624	1
TUBE,3.5X5.5X19 (Ref # 92191)	92191-1217	2
NUT,SPECIAL,5MM (Ref # 92210)	92210-1060	4