

2001 Vulcan 800 PARTS DIAGRAM

Side Covers/Chain Cover

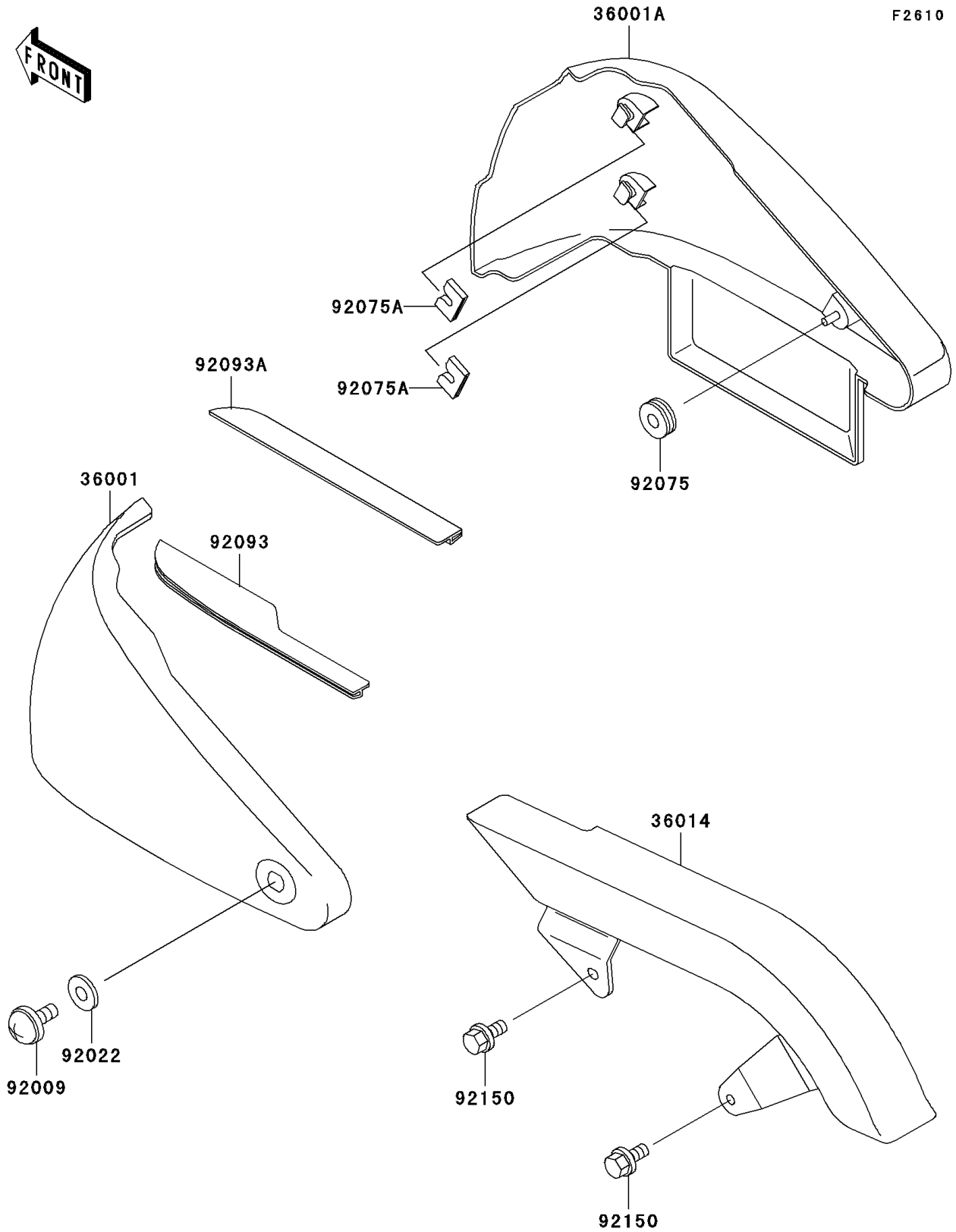

2001 Vulcan 800 PARTS LIST

Side Covers/Chain Cover

ITEM NAME	PART NUMBER	QUANTITY
COVER-SIDE,LH,EBONY (Ref # 36001)	36001-1550-H8	1
COVER-SIDE,RH,EBONY (Ref # 36001A)	36001-1551-H8	1
CASE-CHAIN (Ref # 36014)	36014-1198	1
SCREW,6X18 (Ref # 92009)	92009-1663	1
WASHER,6.5X16X1 (Ref # 92022)	92022-1143	1
DAMPER (Ref # 92075)	92075-1629	1
DAMPER (Ref # 92075A)	92075-1967	4
SEAL,SIDE COVER,LH (Ref # 92093)	92093-1405	1
SEAL,SIDE COVER,RH (Ref # 92093A)	92093-1406	1
BOLT,6X14 (Ref # 92150)	92150-1340	2