

# 2000 Vulcan 800 PARTS DIAGRAM

Crankcase Bolt Pattern

E1412

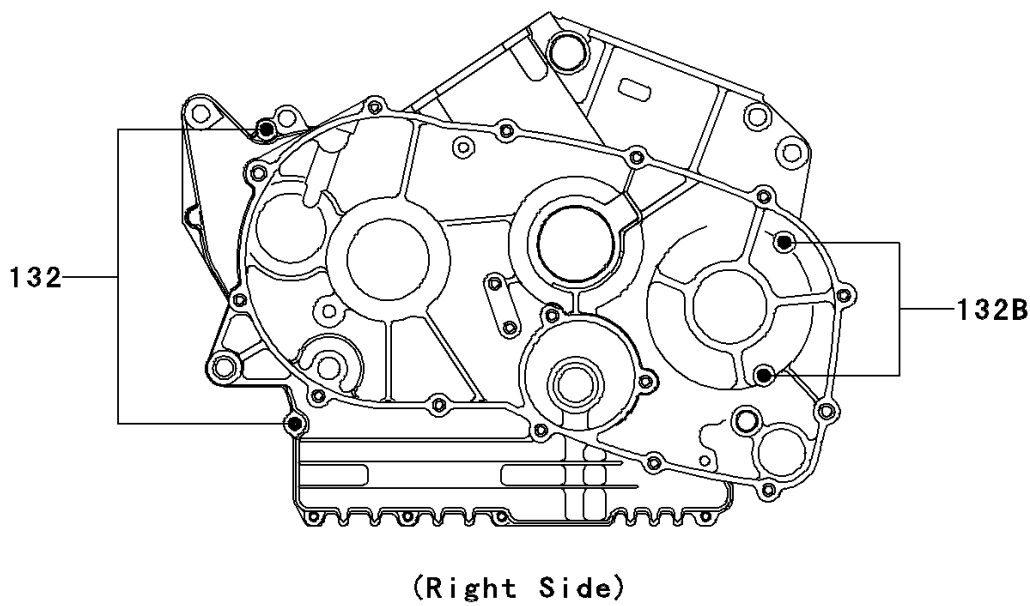
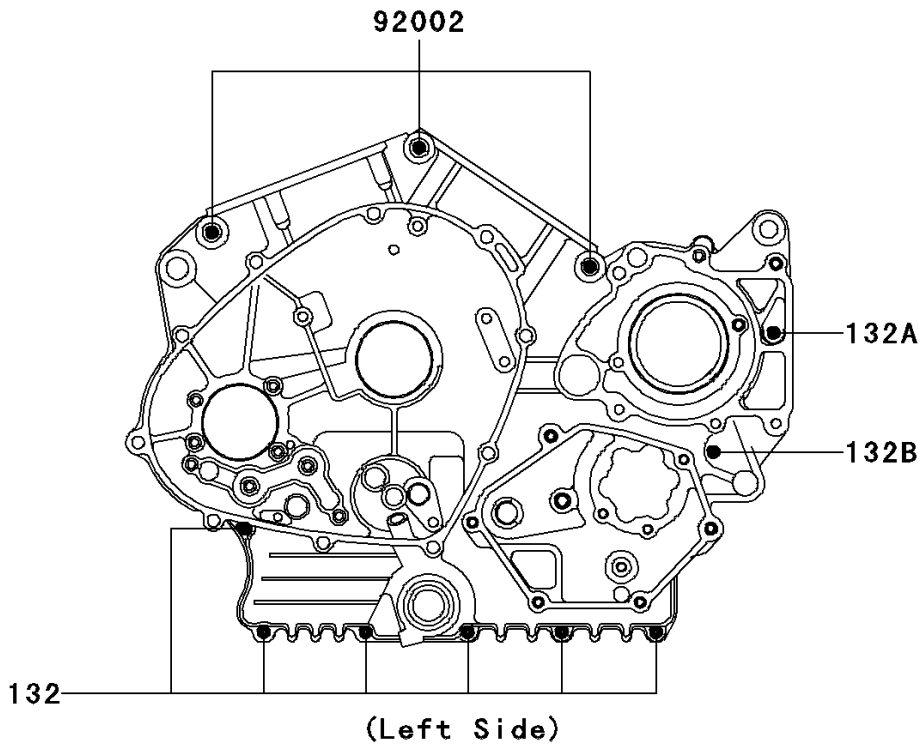

## 2000 Vulcan 800 PARTS LIST

### Crankcase Bolt Pattern

ITEM NAME	PART NUMBER	QUANTITY
BOLT-FLANGED-SMALL (Ref # 132)	132J0630	8
BOLT-FLANGED-SMALL,6X40 (Ref # 132A)	132J0640	1
BOLT-FLANGED-SMALL (Ref # 132B)	132J0660	3
BOLT,10X80 (Ref # 92002)	92002-1542	3