

1991 Vulcan 750 PARTS DIAGRAM

Oil Pump

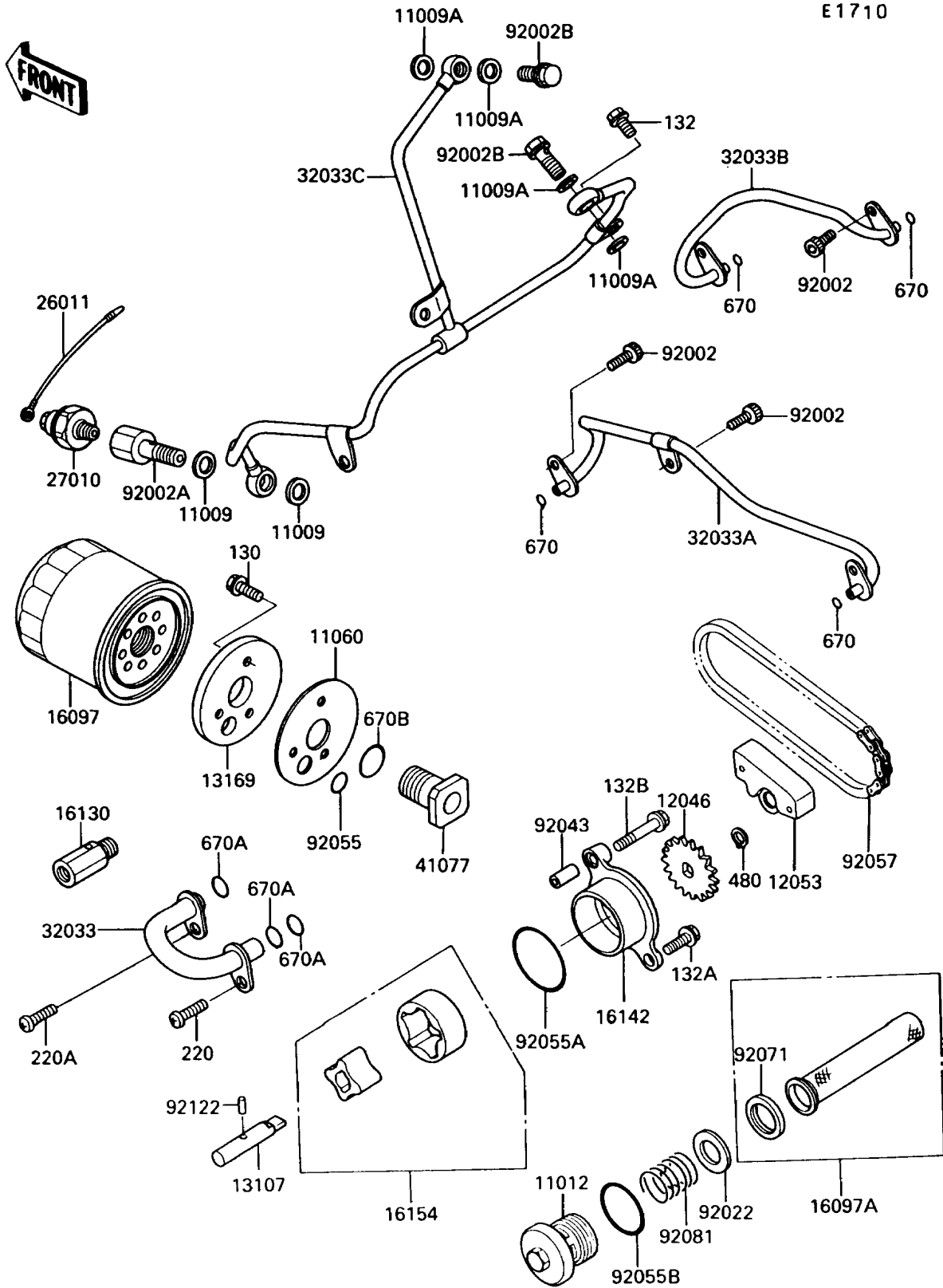

1991 Vulcan 750 PARTS LIST

Oil Pump

ITEM NAME	PART NUMBER	QUANTITY
BOLT-FLANGED (Ref # 130)	130P0514	1
BOLT-FLANGED-SMALL (Ref # 132)	132E0612	1
BOLT-FLANGED-SMALL (Ref # 132A)	132G0616	1
BOLT-FLANGED-SMALL (Ref # 132B)	132G0630	1
SCREW-PAN-CROS,6X16 (Ref # 220)	220B0616	1
SCREW-PAN-CROS,6X20,WHITE (Ref # 220A)	220B0620	1
CIRCLIP-TYPE-C,11MM (Ref # 480)	480J1100	1
O RING,6MM (Ref # 670)	670D1506	1
GASKET,10X14.5X1.5 (Ref # 11009)	11009-1105	1
GASKET,OIL PIPE,8.2X14X1.0 (Ref # 11009A)	11009-1344	1
CAP,OIL FILTER (Ref # 11012)	11012-1483	1
GASKET,OIL FILTER (Ref # 11060)	11060-1092	1
SPROCKET,OIL PUMP,19T (Ref # 12046)	12046-1079	1
GUIDE-CHAIN (Ref # 12053)	12053-1187	1
SHAFT,OIL PUMP (Ref # 13107)	13107-1131	1
PLATE,OIL FILTER (Ref # 13169)	13169-1921	1
FILTER-ASSY-OIL (Ref # 16097)	16097-1054	1
FILTER-ASSY-OIL (Ref # 16097A)	16097-1058	1
VALVE-ASSY-RELIEF (Ref # 16130)	16130-1001	1
COVER-PUMP,OIL (Ref # 16142)	16142-1061	1
ROTOR-PUMP (Ref # 16154)	16154-1056	1
WIRE-LEAD (Ref # 26011)	26011-1295	1
SWITCH,OIL PRESSURE (Ref # 27010)	27010-1155	1
PIPE,OIL,PUMP-FILTER (Ref # 32033)	32033-1479	1
PIPE,OIL,FILTER-TRANSMISSION (Ref # 32033A)	32033-1741	1
PIPE,OIL,FILTER-CRANKSHAFT (Ref # 32033B)	32033-1742	1
PIPE,FILTER-HEAD (Ref # 32033C)	32033-1863	1
ADAPTER,OIL FILTER (Ref # 41077)	41077-1052	1
BOLT,SOCKET,6X14 (Ref # 92002)	92002-1592	1

1991 Vulcan 750 PARTS LIST

Oil Pump

ITEM NAME	PART NUMBER	QUANTITY
BOLT,OIL SWITCH (Ref # 92002A)	92002-1617	1
BOLT,BANJO,8X20 (Ref # 92002B)	92002-1618	1
WASHER,16.5X28X0.5 (Ref # 92022)	92022-169	1
PIN,6.2X8X14 (Ref # 92043)	92043-1263	1
RING-O,13X1.9 (Ref # 92055)	92055-1021	1
RING-O,44.7X2.4 (Ref # 92055A)	92055-1279	1
RING-O,35.2X2.4 (Ref # 92055B)	92055-1358	1
CHAIN,PUMP,BS25HX50L (Ref # 92057)	92057-1183	1
GROMMET,OIL STRAINER (Ref # 92071)	92071-100	1
SPRING,OIL FILTER (Ref # 92081)	92081-1862	1
ROLLER,3X15.8 (Ref # 92122)	92122-1126	1
O RING,12MM (Ref # 670A)	670D2012	1
O RING,20MM (Ref # 670B)	670D2020	1