

1990 Vulcan 750 PARTS DIAGRAM

Clutch

E1350

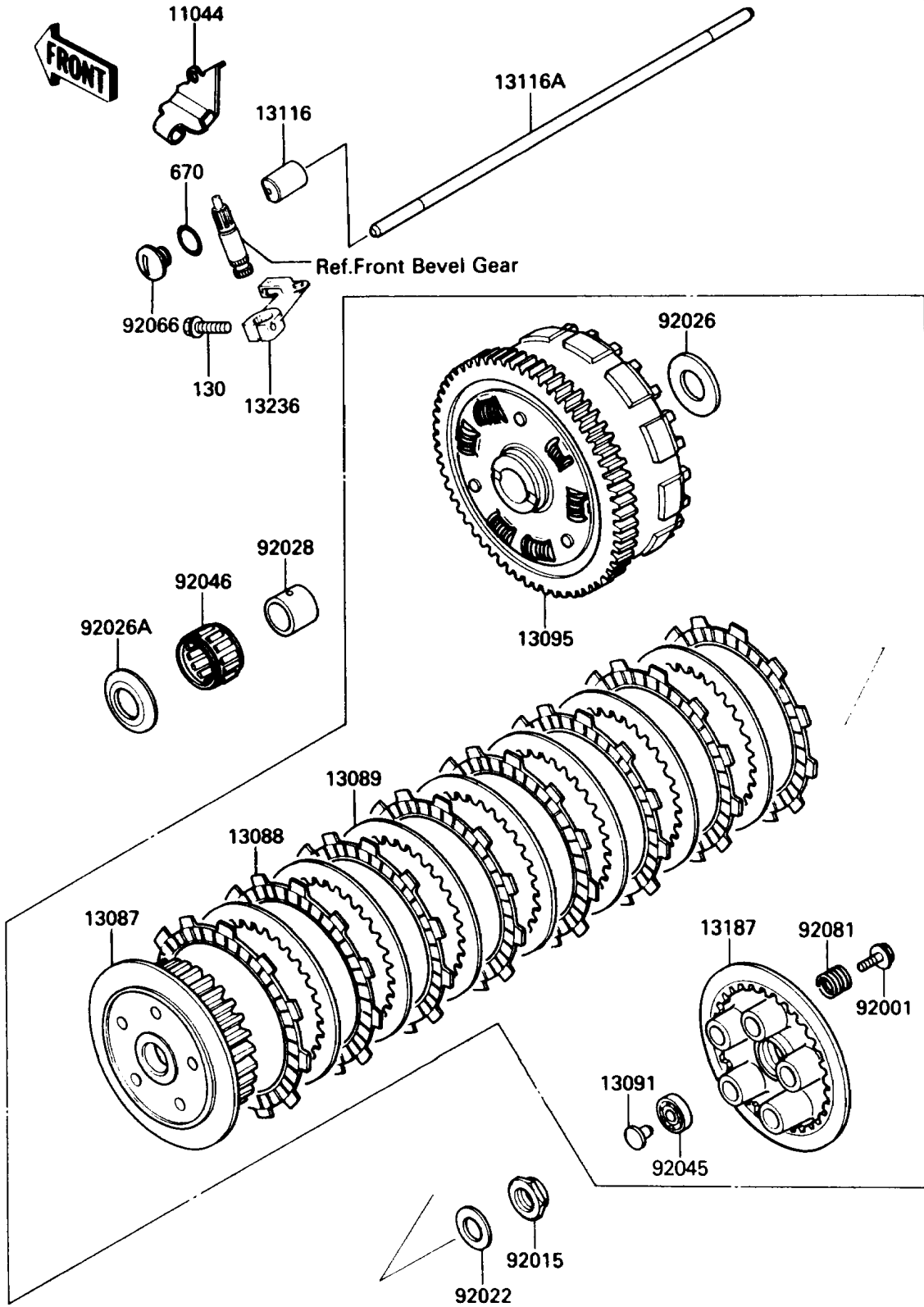

1990 Vulcan 750 PARTS LIST

Clutch

ITEM NAME	PART NUMBER	QUANTITY
BOLT-FLANGED,6X20 (Ref # 130)	130P0620	1
O RING,15MM (Ref # 670)	670B2015	1
BRACKET,CLUTCH CABLE (Ref # 11044)	11044-1473	1
HUB-CLUTCH (Ref # 13087)	13087-042	1
PLATE-FRICTION (Ref # 13088)	13088-1087	1
PLATE-CLUTCH (Ref # 13089)	13089-027	1
HOLDER,CLUTCH PUSH ROD (Ref # 13091)	13091-1085	1
HOUSING-COMP-CLUTCH (Ref # 13095)	13095-1119	1
ROD-PUSH,CLUTCH,6T (Ref # 13116)	13116-1040	1
ROD-PUSH,L=316.5 (Ref # 13116A)	13116-1114	1
PLATE-CLUTCH OPERATING (Ref # 13187)	13187-1006	1
LEVER-COMP,CLUTCH RELEASE (Ref # 13236)	13236-1140	1
BOLT,FLANGED,6X18 (Ref # 92001)	92001-1066	1
NUT,20MM (Ref # 92015)	92015-1555	1
WASHER,20.3X36X2.3 (Ref # 92022)	92022-1116	1
SPACER,25.5X47X2.5 (Ref # 92026)	92026-022	1
SPACER,THRUST,T=5.5 (Ref # 92026A)	92026-116	1
BUSHING,25X32X23.6 (Ref # 92028)	92028-178	1
BEARING-BALL,6001C3ML01 (Ref # 92045)	92045-1235	1
BEARING-NEEDLE,KTV323723 (Ref # 92046)	92046-028	1
PLUG (Ref # 92066)	92066-1237	1
SPRING,CLUTCH (Ref # 92081)	92081-1033	1