

2003 Vulcan 1500 Drifter PARTS DIAGRAM

Clutch Master Cylinder

F2380

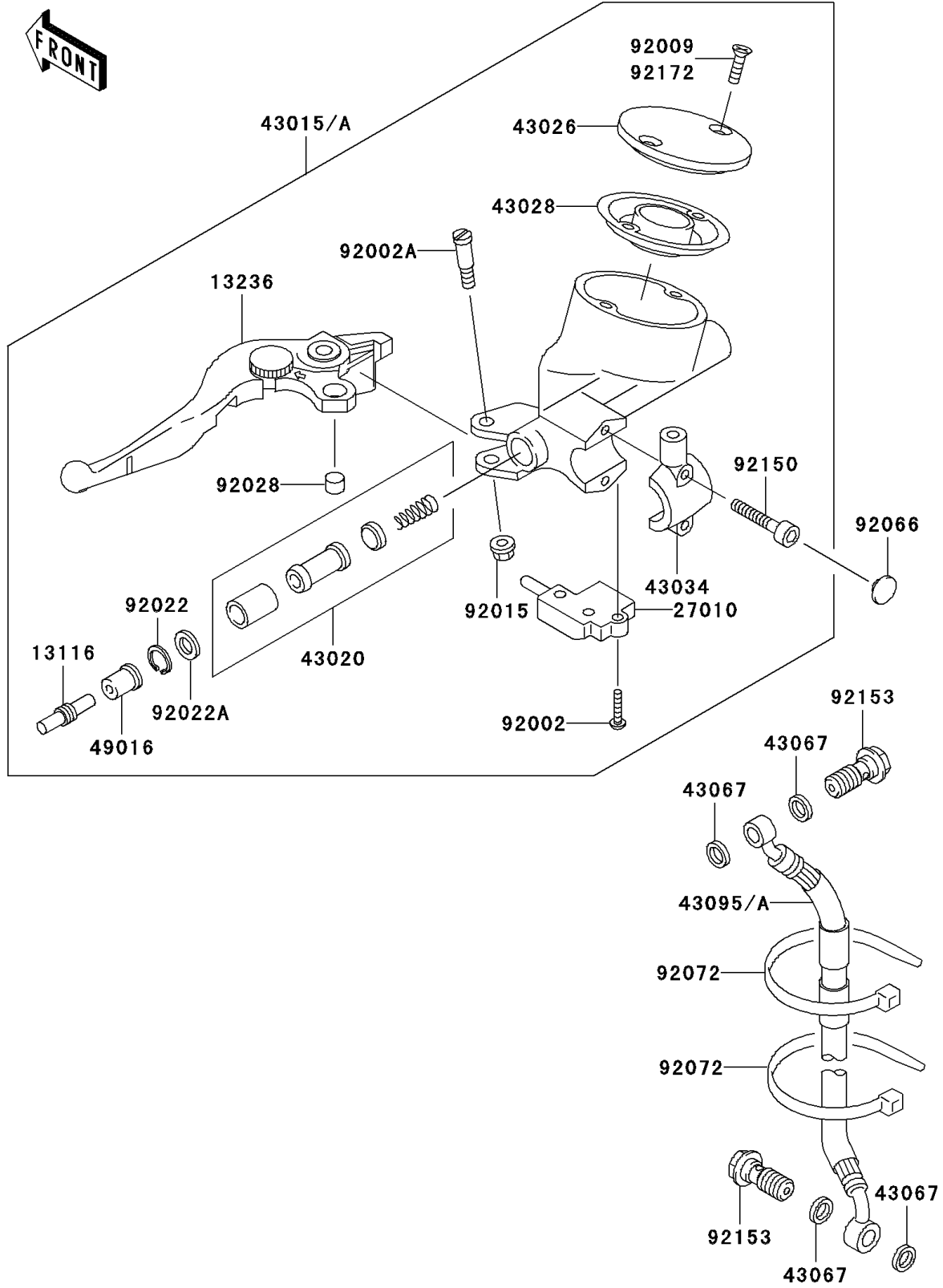

2003 Vulcan 1500 Drifter PARTS LIST

Clutch Master Cylinder

ITEM NAME	PART NUMBER	QUANTITY
ROD-PUSH,MASTER CYLINDER (Ref # 13116)	13116-1110	1
LEVER-COMP,CLUTCH (Ref # 13236)	13236-1316	1
SWITCH,CLUTCH (Ref # 27010)	27010-1406	1
CYLINDER-ASSY-MASTER,CLUTCH (Ref # 43015A)	43015-1621	1
PISTON-COMP-BRAKE,CLUTCH (Ref # 43020)	43020-1055	1
CAP-BRAKE (Ref # 43026)	43026-1083	1
DIAPHRAGM,MASTER CYLINDER (Ref # 43028)	43028-1071	1
HOLDER-BRAKE (Ref # 43034)	43034-1147	1
WASHER,10.5X15X1.5 (Ref # 43067)	43067-001	4
HOSE-BRAKE,CLUTCH (Ref # 43095)	43095-1203	1
COVER-SEAL,MASTER CYLINDER (Ref # 49016)	49016-1044	1
SCREW,4X16 (Ref # 92002)	92002-1325	1
BOLT,LEVER SET (Ref # 92002A)	92002-1561	1
SCREW,5MM (Ref # 92009)	92009-1440	2
NUT,FLANGED,6MM (Ref # 92015)	92015-1528	1
CIRCLIP (Ref # 92022)	92022-1605	1
WASHER,PISTON (Ref # 92022A)	92022-1606	1
BUSHING,MASTER CYLINDER (Ref # 92028)	92028-1310	1
PLUG (Ref # 92066)	92066-1301	2
BAND,L=365 (Ref # 92072)	92072-1197	2
BOLT,SOCKET,6MM (Ref # 92150)	92150-1025	2
BOLT,OIL,L=23 (Ref # 92153)	92153-0627	2