

# 2003 Vulcan 1500 Drifter PARTS DIAGRAM

Footrests

F2160

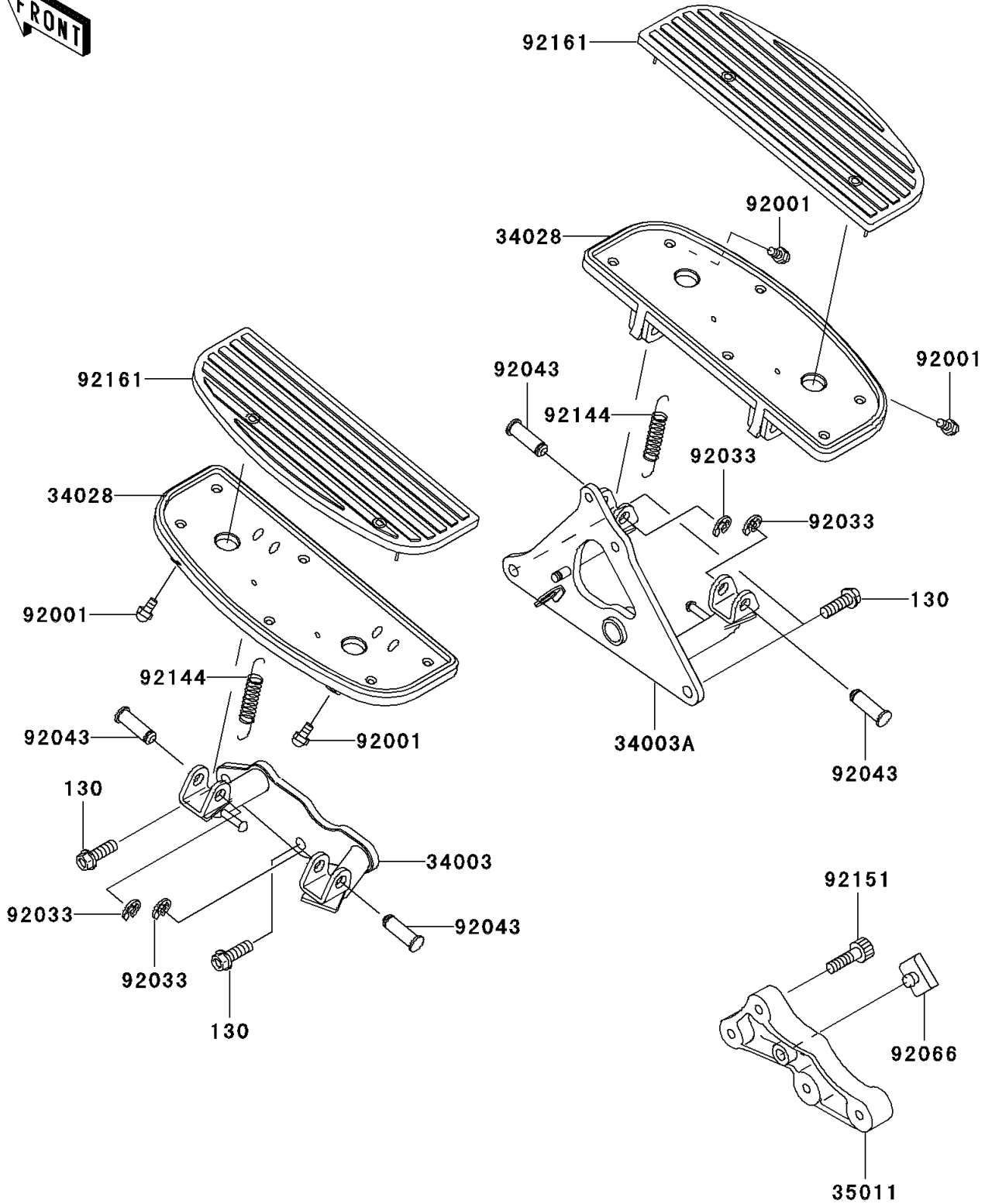

## 2003 Vulcan 1500 Drifter PARTS LIST

### Footrests

ITEM NAME	PART NUMBER	QUANTITY
BOLT-FLANGED,10X30 (Ref # 130)	130J1030	4
HOLDER-STEP,FR,LH (Ref # 34003)	34003-1501	1
HOLDER-STEP,FR,RH (Ref # 34003A)	34003-1502	1
STEP,FR (Ref # 34028)	34028-1497	2
STAY,REAR STEP,RH (Ref # 35011)	35011-1974	1
BOLT,BANK SENSOR (Ref # 92001)	92001-1905	4
RING-SNAP,10MM (Ref # 92033)	92033-1166	4
PIN,12X37 (Ref # 92043)	92043-1358	4
PLUG (Ref # 92066)	92066-1548	1
SPRING,BRAKE PEDAL RETURN (Ref # 92144)	92144-1266	2
BOLT,SOCKET,8X25 (Ref # 92151)	92151-1525	2
DAMPER,FRONT STEP (Ref # 92161)	92161-1154	2