

2003 Vulcan 1500 Drifter PARTS DIAGRAM

Crankcase Bolt Pattern

E1412

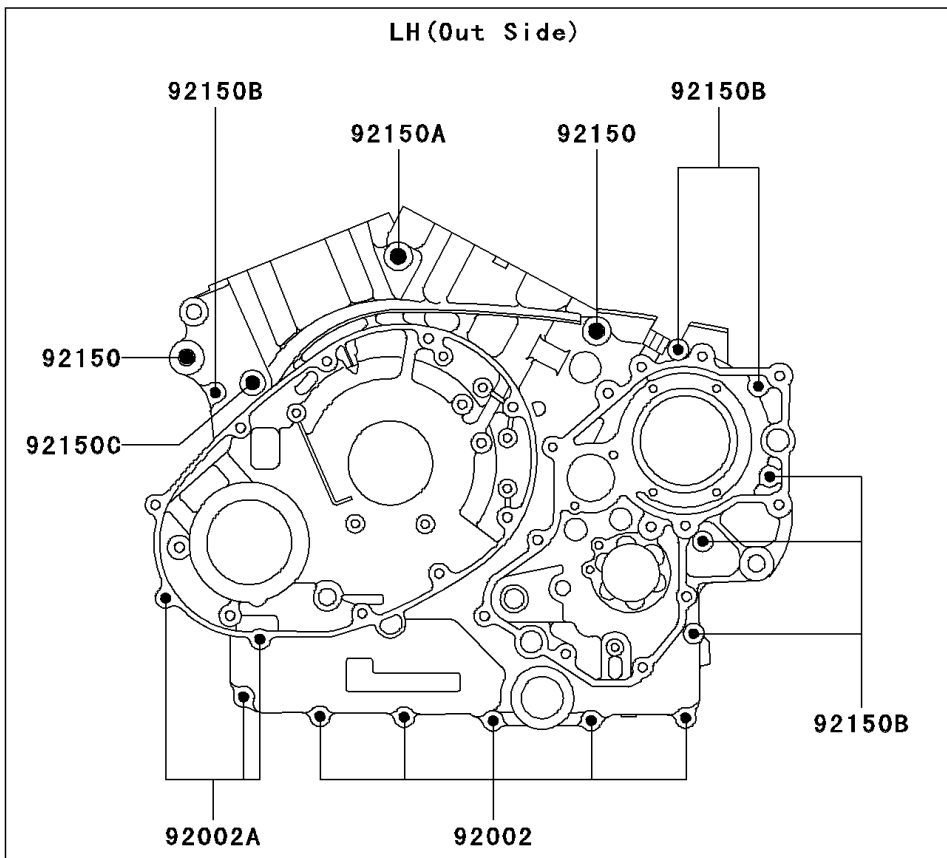
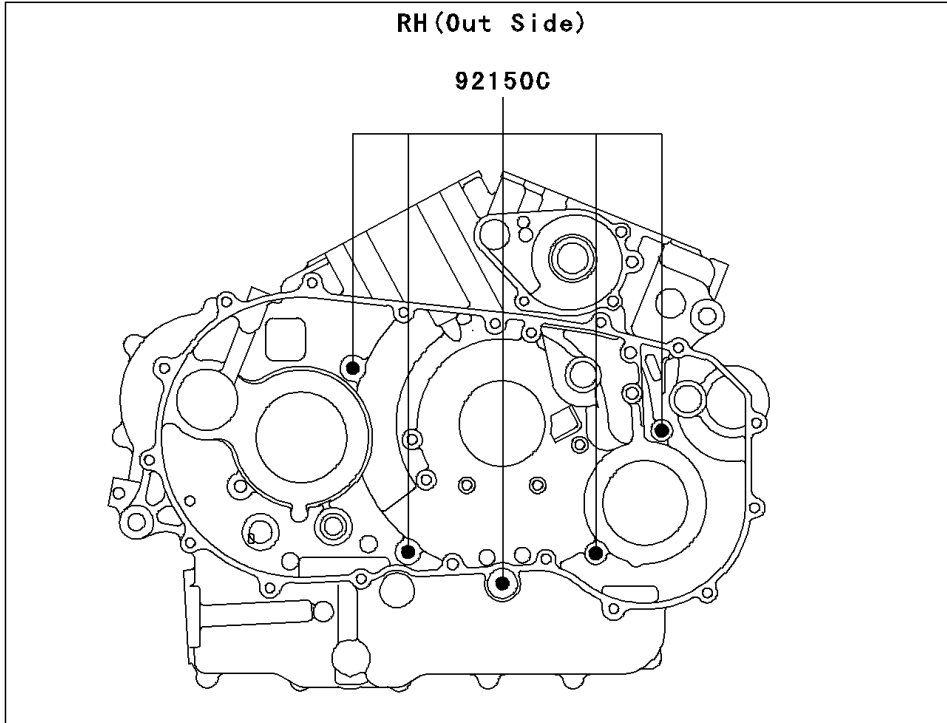

2003 Vulcan 1500 Drifter PARTS LIST

Crankcase Bolt Pattern

ITEM NAME	PART NUMBER	QUANTITY
BOLT,6X40 (Ref # 92002)	92002-1566	5
BOLT,6X80 (Ref # 92002A)	92002-1568	3
BOLT,10X105 (Ref # 92150)	92150-1993	2
BOLT,10X115 (Ref # 92150A)	92150-1994	1
BOLT,6X70 (Ref # 92150B)	92150-1995	6
BOLT,8X90 (Ref # 92150C)	92150-1996	6