

2003 Vulcan 1500 Mean Streak PARTS DIAGRAM

Tires

F2210

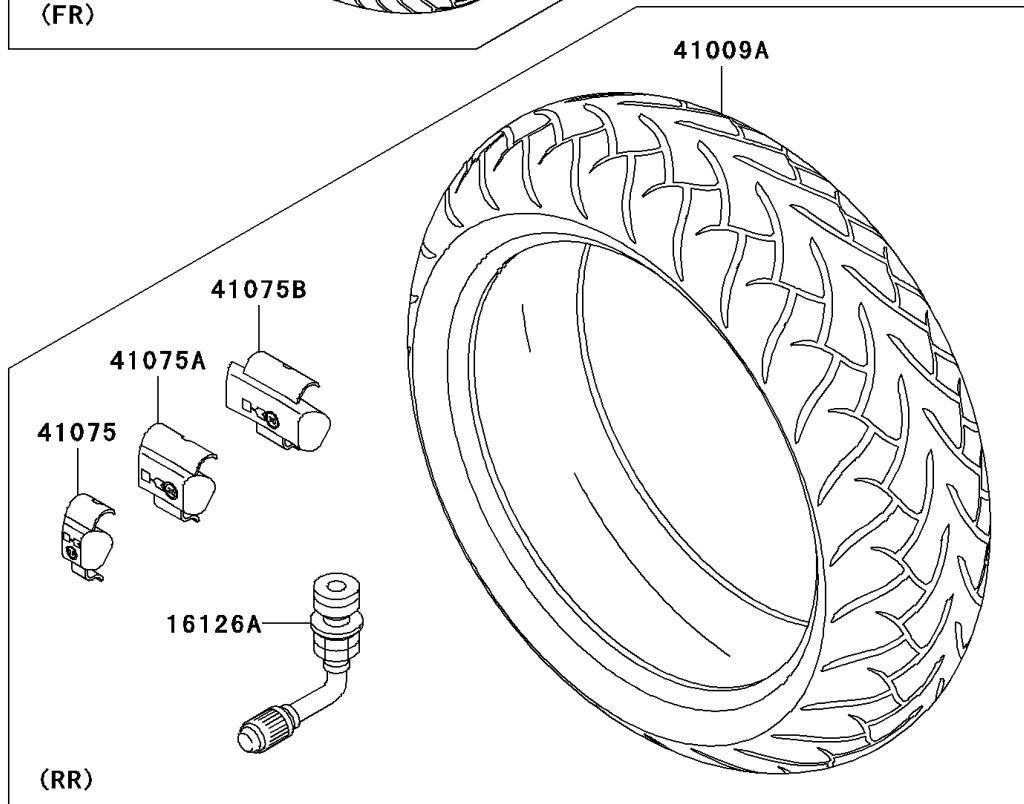
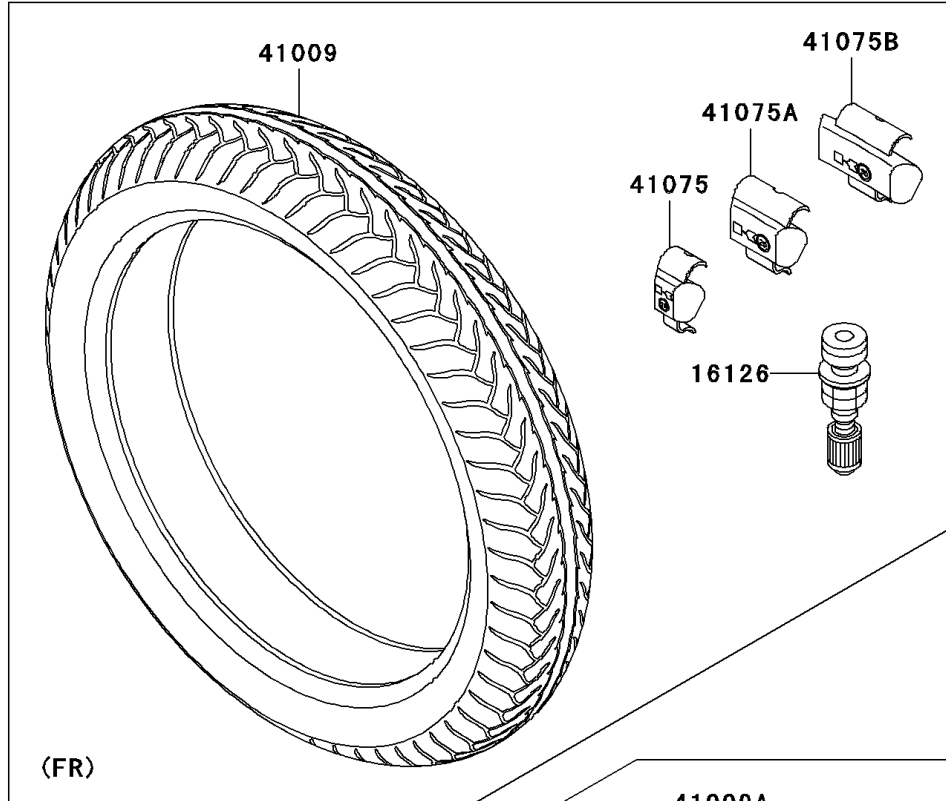

2003 Vulcan 1500 Mean Streak PARTS LIST

Tires

ITEM NAME	PART NUMBER	QUANTITY
VALVE,TIRE (Ref # 16126)	16126-1136	1
VALVE,TIRE (Ref # 16126A)	16126-1191	1
TIRE,FR,130/70R17 62H,D220FSTG (Ref # 41009)	41009-1397	1
TIRE,RR,170/60R17 72H,D220STG (Ref # 41009A)	41009-1398	1
BALANCER-WHEEL,10G,SILVER (Ref # 41075)	41075-1014	AR
BALANCER-WHEEL,20G,SILVER (Ref # 41075A)	41075-1015	AR
BALANCER-WHEEL,30G,SILVER (Ref # 41075B)	41075-1016	AR