

2019 KX™ 450 PARTS DIAGRAM

Oil Pump

E1712

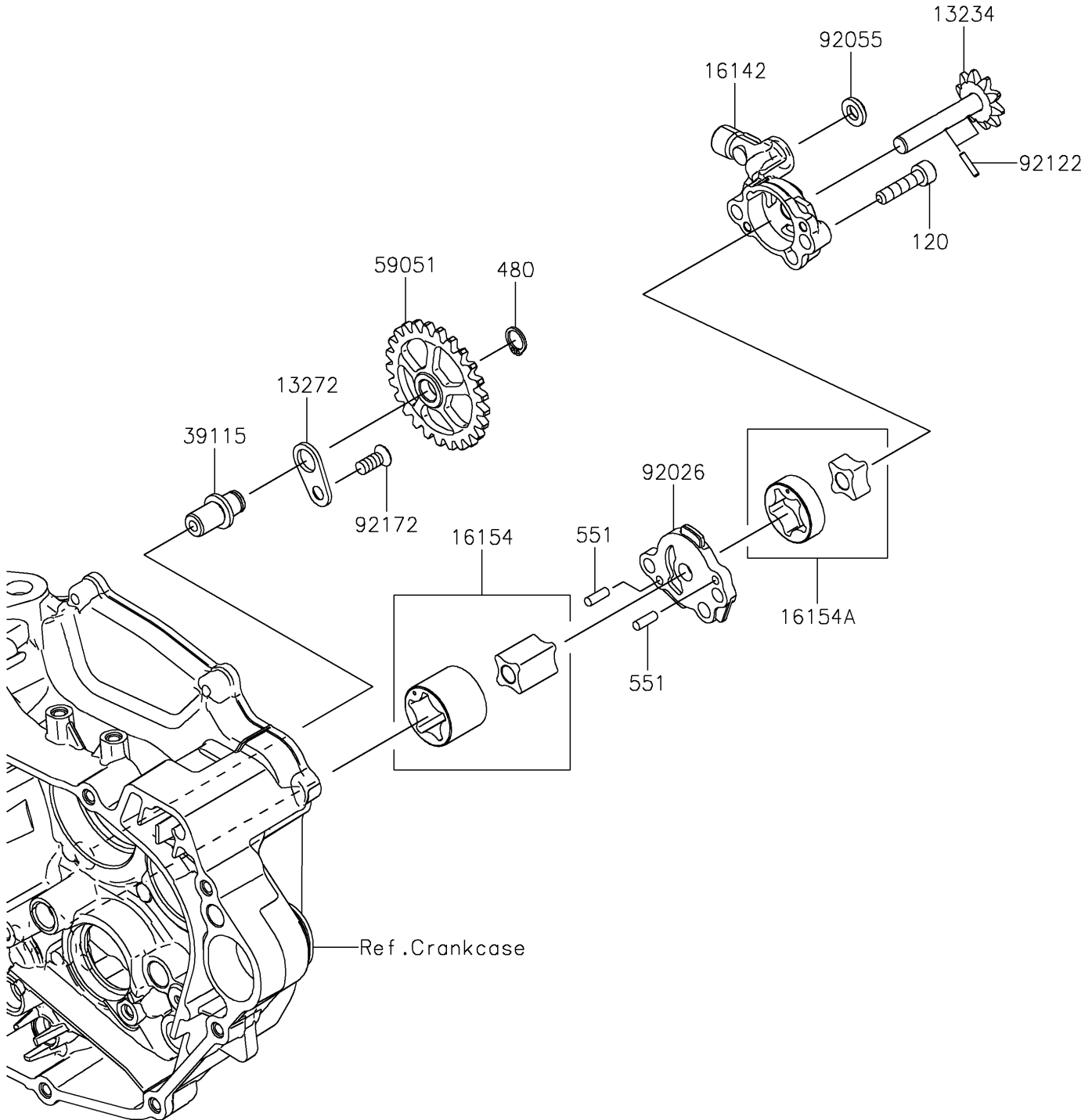

2019 KX™ 450 PARTS LIST

Oil Pump

ITEM NAME	PART NUMBER	QUANTITY
SHAFT-COMP,10T (Ref # 13234)	13234-0604	1
PLATE (Ref # 13272)	13272-1944	1
COVER-PUMP,OIL (Ref # 16142)	16142-5003	1
ROTOR-PUMP,SCAVENGE (Ref # 16154)	16154-0726	1
ROTOR-PUMP,FEED (Ref # 16154A)	16154-0729	1
SHAFT-IDLER (Ref # 39115)	39115-0024	1
GEAR-SPUR,OIL PUMP DRIVE,25T (Ref # 59051)	59051-0770	1
SPACER (Ref # 92026)	92026-0804	1
RING-O,OD=13 (Ref # 92055)	92055-074	1
ROLLER,2.5X11.8 (Ref # 92122)	92122-0021	2
SCREW,6X14 (Ref # 92172)	92172-0087	1
BOLT-SOCKET,6X25 (Ref # 120)	120CA0625	2
CIRCLIP-TYPE-C,10MM (Ref # 480)	480J1000	1
PIN-DOWEL (Ref # 551)	551A0412	2