

2002 Vulcan 1500 Classic Fi PARTS DIAGRAM

Crankcase Bolt Pattern

E1412

RH (Out Side)

92150A

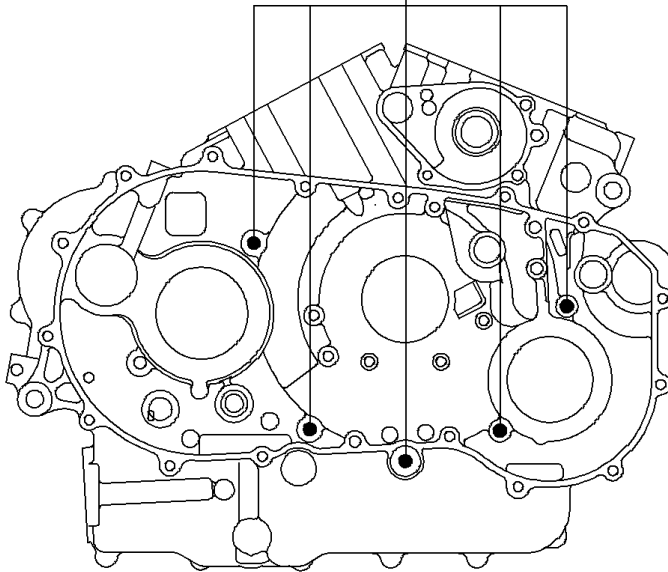

LH (Out Side)

92150

92150A

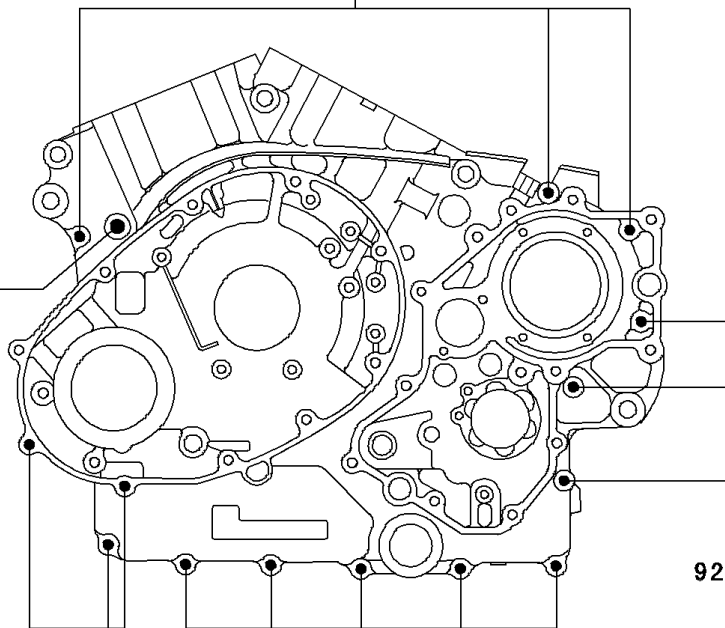

92150

92002A

92002

2002 Vulcan 1500 Classic Fi PARTS LIST

Crankcase Bolt Pattern

ITEM NAME	PART NUMBER	QUANTITY
BOLT,6X40 (Ref # 92002)	92002-1566	5
BOLT,6X80 (Ref # 92002A)	92002-1568	3
BOLT,6X70 (Ref # 92150)	92150-1995	6
BOLT,8X90 (Ref # 92150A)	92150-1996	6