

2022 Concours®14 ABS PARTS DIAGRAM

Handlebar

F2310

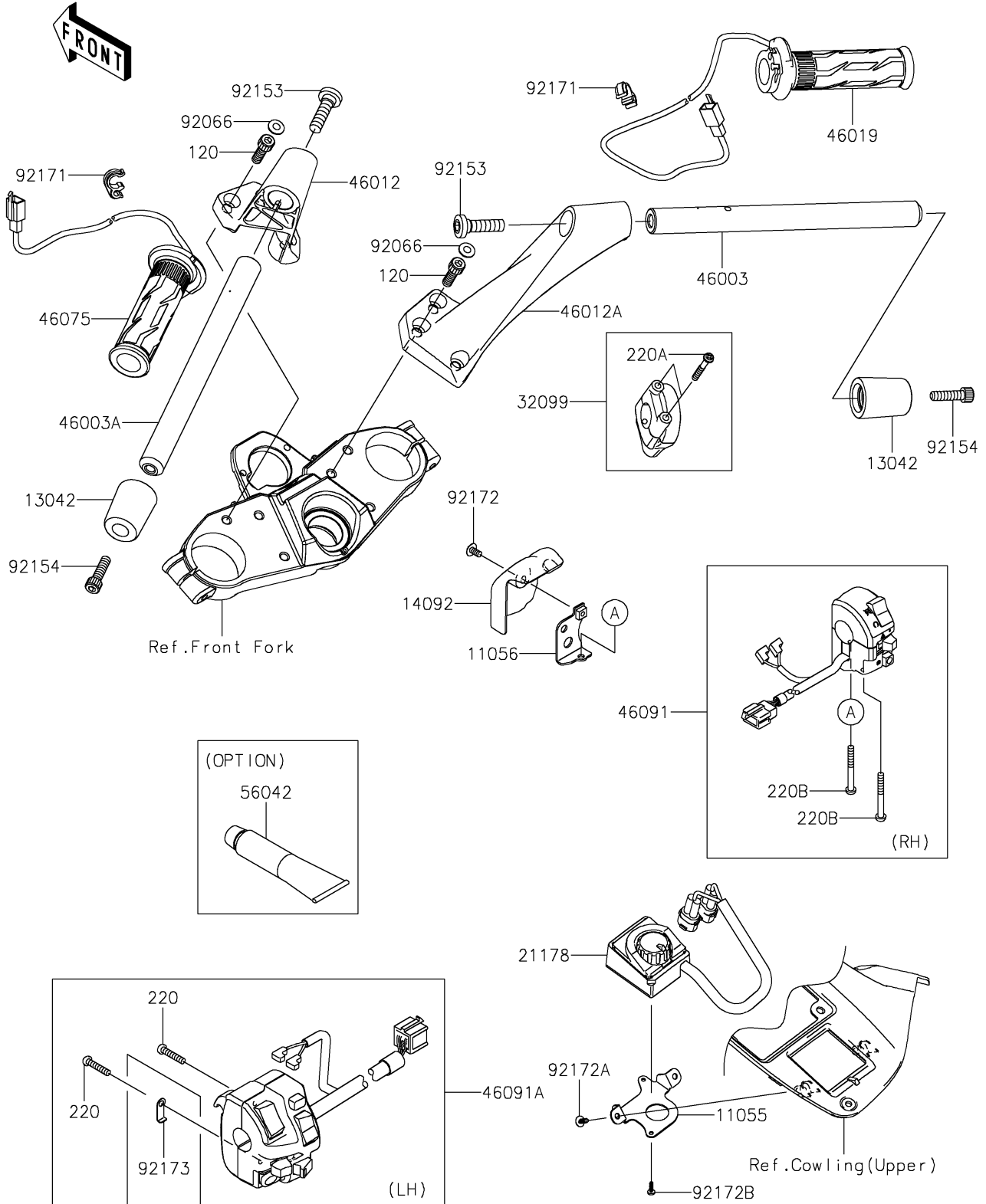

2022 Concours®14 ABS PARTS LIST

Handlebar

ITEM NAME	PART NUMBER	QUANTITY
BRACKET,CONTROL SWITCH (Ref # 11055)	11055-1753	1
BRACKET (Ref # 11056)	11056-0154	1
WEIGHT,HANDLE (Ref # 13042)	13042-5002	2
COVER (Ref # 14092)	14092-0126	1
CONTROL-SWITCH,GRIP HEATERS (Ref # 21178)	21178-0004	1
CASE,THROTTLE (Ref # 32099)	32099-0769	1
HANDLE,RH (Ref # 46003)	46003-0177	1
HANDLE,LH (Ref # 46003A)	46003-0191	1
HOLDER-HANDLE,LH,F.S.BLACK (Ref # 46012)	46012-0086-18R	1
HOLDER-HANDLE,RH,F.S.BLACK (Ref # 46012A)	46012-0087-18R	1
GRIP-ASSY,THROTTLE,HEATER (Ref # 46019)	46019-0111	1
GRIP,LH,HEATER (Ref # 46075)	46075-0653	1
HOUSING-ASSY-CONTROL,RH (Ref # 46091)	46091-0189	1
HOUSING-ASSY-CONTROL,LH (Ref # 46091A)	46091-0202	1
ADHESIVE,TB1530C (Ref # 56042)	56042-0001	1
PLUG (Ref # 92066)	92066-1216	6
BOLT,SOCKET,10X37 (Ref # 92153)	92153-1440	2
BOLT,SOCKET,8X30 (Ref # 92154)	92154-1866	2
CLAMP,BRAKE HOSE (Ref # 92171)	92171-1819	2
SCREW,5X10 (Ref # 92172)	92172-0007	1
SCREW,TAPPING,4X10 (Ref # 92172A)	92172-0172	2
SCREW,TAPPING,3X10 (Ref # 92172B)	92172-0351	2
CLAMP (Ref # 92173)	92173-0177	1
BOLT-SOCKET,8X25 (Ref # 120)	120CA0825	6
SCREW-PAN-CROS,5X25 (Ref # 220)	220AB0525	2
SCREW-PAN-CROS,5X35 (Ref # 220A)	220AB0535	2
SCREW-PAN-CROS,5X45 (Ref # 220B)	220AB0545	2