

2000 Vulcan 1500 Nomad PARTS DIAGRAM

Ignition System

E1830

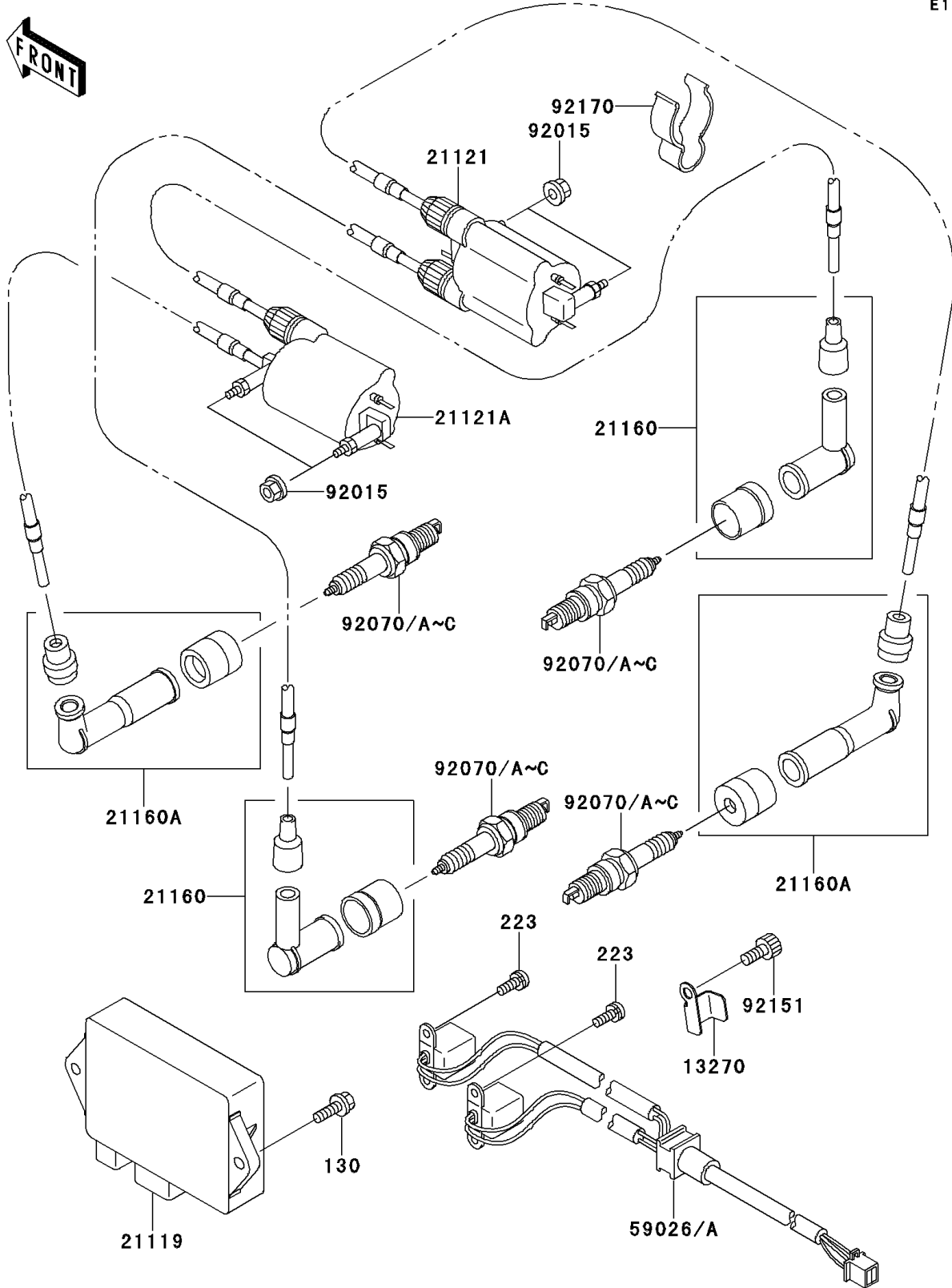

2000 Vulcan 1500 Nomad PARTS LIST

Ignition System

ITEM NAME	PART NUMBER	QUANTITY
BOLT-FLANGED (Ref # 130)	130H0620	2
SCREW-PAN-WS-CROS (Ref # 223)	223B0516	4
PLATE (Ref # 13270)	13270-1979	1
IGNITER (Ref # 21119)	21119-1515	1
COIL-IGNITION,RR (Ref # 21121)	21121-1288	1
COIL-IGNITION,FR (Ref # 21121A)	21121-1289	1
CAP-ASSY-PLUG (Ref # 21160)	21160-1085	2
CAP-ASSY-PLUG (Ref # 21160A)	21160-1091	2
COIL-PULSING (Ref # 59026)	59026-1145	1
NUT,CAP,6MM,BLACK (Ref # 92015)	92015-1170	4
PLUG-SPARK,DPR6EA9(NGK) (Ref # 92070)	92070-1138	AR
PLUG-SPARK,X20EPR-U9(ND) (Ref # 92070A)		AR
PLUG-SPARK,DPR5EA9(NGK) (Ref # 92070B)	92070-1250	4
PLUG-SPARK,X16EPR-U9(ND) (Ref # 92070C)		4
BOLT,SOCKET,6X10 (Ref # 92151)	92151-3704	1
CLAMP,HOSE (Ref # 92170)	92170-1930	4