

2018 KLX® 250 PARTS DIAGRAM

Front Fork

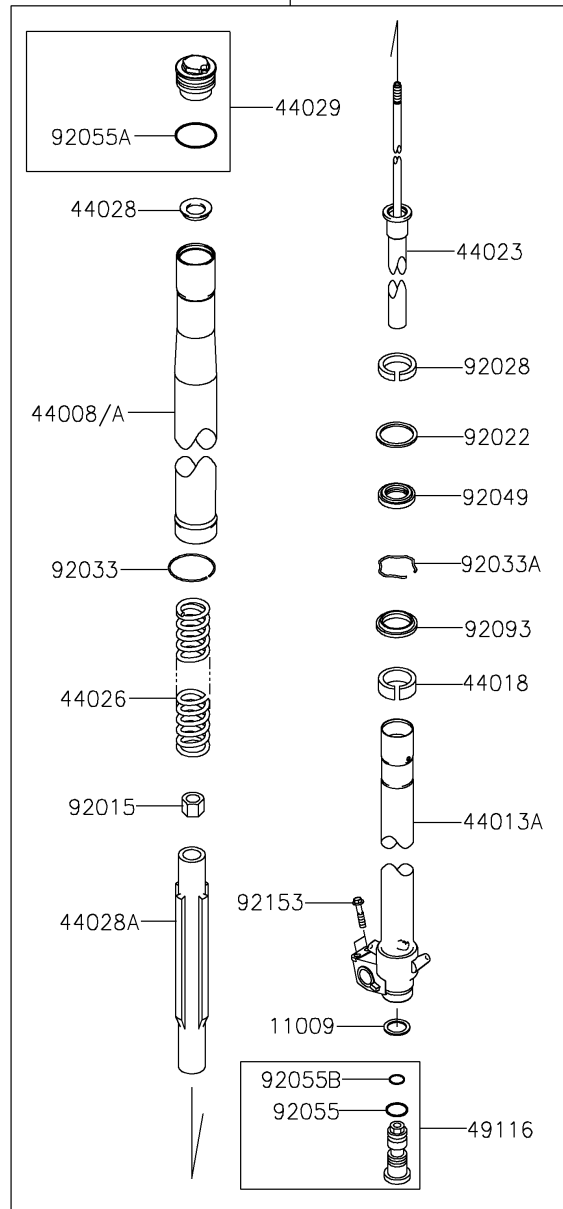
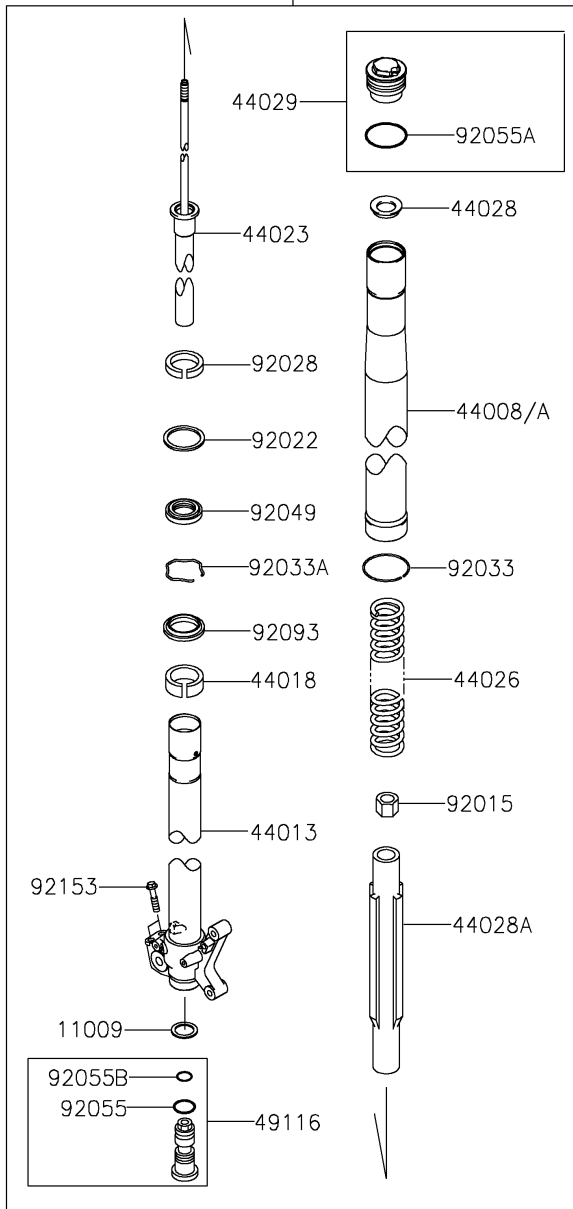
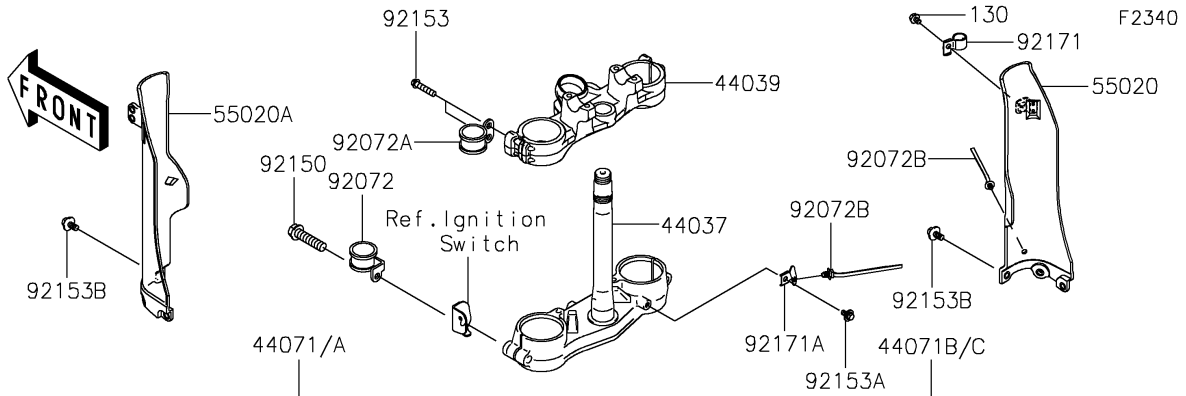

2018 KLX® 250 PARTS LIST

Front Fork

ITEM NAME	PART NUMBER	QUANTITY
GASKET,FORK CYLINDER BOLT (Ref # 11009)	11009-1592	2
PIPE-FORK OUTER,SILVER (Ref # 44008A)	44008-0032-KX	2
PIPE-FORK INNER,LH,P.SILVER (Ref # 44013)	44013-0090-458	1
PIPE-FORK INNER,RH,P.SILVER (Ref # 44013A)	44013-0092-458	1
PISTON-FORK,INNER PIPE (Ref # 44018)	44018-1056	2
CYLINDER-SET-FORK (Ref # 44023)	44023-0062	2
SPRING-FRONT FORK (Ref # 44026)	44026-0103	2
GUIDE-FORK SPRING (Ref # 44028)	44028-1081	2
GUIDE-FORK SPRING (Ref # 44028A)	44028-1084	2
SEAT-FORK SPRING,SILVER (Ref # 44029)	44029-0010-KX	2
HOLDER-FORK UNDER,F.S.BLACK (Ref # 44037)	44037-0078-18R	1
HOLDER-FORK UPPER,F.S.BLACK (Ref # 44039)	44039-0059-18R	1
DAMPER-ASSY,FORK,LH,SILVER (Ref # 44071)	44071-0431-22S	1
DAMPER-ASSY,FORK,RH,SILVER (Ref # 44071B)	44071-0432-22S	1
VALVE-ASSY,FORK (Ref # 49116)	49116-1168	2
GUARD,FORK,RH,EBONY (Ref # 55020)	55020-0320-6C	1
GUARD,FORK,LH,EBONY (Ref # 55020A)	55020-0484-6C	1
NUT (Ref # 92015)	92015-1839	2
WASHER (Ref # 92022)	92022-1299	2
BUSHING (Ref # 92028)	92028-1581	2
RING-SNAP (Ref # 92033)	92033-0080	2
RING-SNAP (Ref # 92033A)	92033-1077	2
SEAL-OIL (Ref # 92049)	92049-1373	2
RING-O (Ref # 92055)	92055-1156	2
RING-O,FORK,AIR TUBE (Ref # 92055A)	92055-1333	2
RING-O,FORK VALVE (Ref # 92055B)	92055-1502	2
BAND (Ref # 92072)	92072-1267	1
BAND (Ref # 92072A)	92072-1283	1
BAND,OS170-FT7(BLACK) (Ref # 92072B)	92072-1414	2

2018 KLX® 250 PARTS LIST

Front Fork

ITEM NAME	PART NUMBER	QUANTITY
SEAL,FORK OUTER TUBE (Ref # 92093)	92093-1342	2
BOLT,FLANGED,8X40 (Ref # 92150)	92150-1446	2
BOLT,8X40 (Ref # 92153)	92153-0020	8
BOLT,6X12 (Ref # 92153A)	92153-0503	1
BOLT,FLANGED,6X14 (Ref # 92153B)	92153-0936	6
CLAMP (Ref # 92171)	92171-1833	1
CLAMP,SPEED SENSOR HARNESS (Ref # 92171A)	92171-1905	1
BOLT-FLANGED,6X8 (Ref # 130)	130BB0608	1