

1996 Vulcan 1500 Classic PARTS DIAGRAM

Drive Shaft/Final Gear

E3132

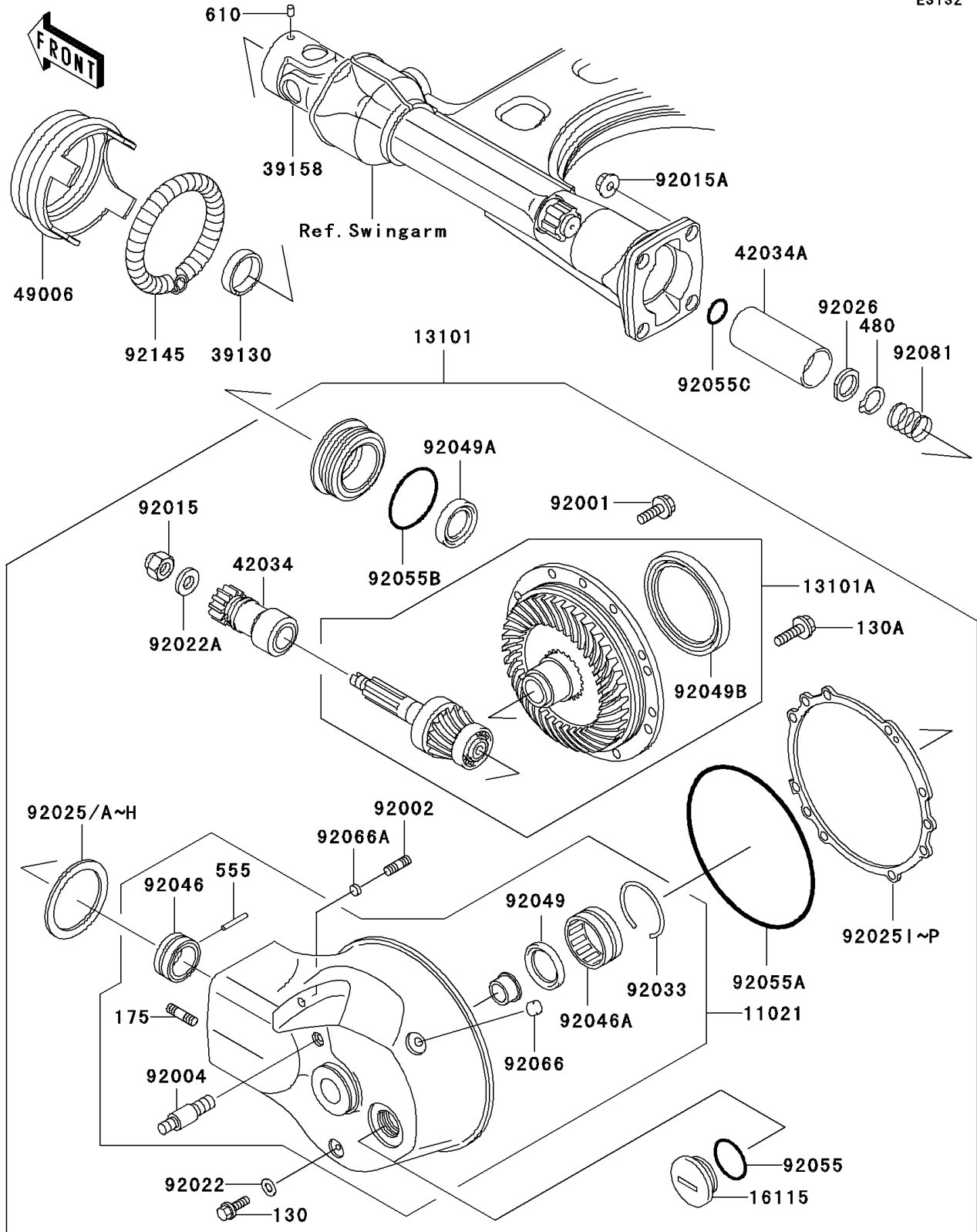

1996 Vulcan 1500 Classic PARTS LIST

Drive Shaft/Final Gear

ITEM NAME	PART NUMBER	QUANTITY
CASE-ASSY,FINAL GEAR (Ref # 11021)	11021-1116	1
GEAR-ASSY,FINAL (Ref # 13101)	13101-1242	1
GEAR-ASSY,BEVEL,RR (Ref # 13101A)	13101-5072	1
CAP-OIL FILLER (Ref # 16115)	16115-1056	1
SPRING-LEAF (Ref # 39130)	39130-1002	1
SHAFT-ASSY-DRIVE (Ref # 39158)	39158-1062	1
COUPLING (Ref # 42034)	42034-1085	1
COUPLING,PROPELLER SHAFT,OUTER (Ref # 42034A)	42034-1092	1
BOOT,PROPELLER SHAFT (Ref # 49006)	49006-1226	1
BOLT,FLANGED,10X23 (Ref # 92001)	92001-1778	1
SCREW-SET-SOCKET,8X18 (Ref # 92002)	92002-1836	1
STUD,RR SHOCKABSORBER (Ref # 92004)	92004-1047	1
NUT,16MM (Ref # 92015)	92015-1059	1
NUT,10MM (Ref # 92015A)	92015-1649	4
WASHER,8.2X16X1 (Ref # 92022)	92022-1086	1
WASHER,16X32X3.2 (Ref # 92022A)	92022-1105	1
SHIM,T=0.10 (Ref # 92025)	92025-1733	AR
SHIM,T=0.15 (Ref # 92025A)	92025-1734	AR
SHIM,T=0.50 (Ref # 92025B)	92025-1735	AR
SHIM,T=0.60 (Ref # 92025C)	92025-1736	AR
SHIM,T=0.70 (Ref # 92025D)	92025-1737	AR
SHIM,T=0.80 (Ref # 92025E)	92025-1738	AR
SHIM,T=0.90 (Ref # 92025F)	92025-1739	AR
SHIM,T=1.00 (Ref # 92025G)	92025-1740	AR
SHIM,T=1.20 (Ref # 92025H)	92025-1741	AR
SHIM,T=0.15 (Ref # 92025I)	92025-1783	AR
SHIM,T=0.50 (Ref # 92025J)	92025-1784	AR
SHIM,T=0.60 (Ref # 92025K)	92025-1785	AR
SHIM,T=0.70 (Ref # 92025L)	92025-1786	AR

1996 Vulcan 1500 Classic PARTS LIST

Drive Shaft/Final Gear

ITEM NAME	PART NUMBER	QUANTITY
SHIM,T=0.80 (Ref # 92025M)	92025-1787	AR
SHIM,T=0.90 (Ref # 92025N)	92025-1788	AR
SHIM,T=1.00 (Ref # 92025O)	92025-1789	AR
SHIM,T=1.20 (Ref # 92025P)	92025-1790	AR
SPACER,PROPELLER SHAFT (Ref # 92026)	92026-1085	1
RING-SNAP,52MM (Ref # 92033)	92033-1074	1
BEARING-NEEDLE,RNA4904RD (Ref # 92046)	92046-1168	1
BEARING-NEEDLE,38NQ5020WD (Ref # 92046A)	92046-1169	1
SEAL-OIL,S-35477HS (Ref # 92049)	92049-1025	1
SEAL-OIL (Ref # 92049A)	92049-1248	1
SEAL-OIL (Ref # 92049B)	92049-1280	1
BOLT-FLANGED (Ref # 130)	130N0812	1
BOLT-FLANGED (Ref # 130A)	130Y0825	7
BOLT-STUD-FINE (Ref # 175)	175G1025	4
CIRCLIP-TYPE-C,26MM (Ref # 480)	480J2600	1
PIN-SPRING (Ref # 555)	555A0428	1
ROLLER,4X6 (Ref # 610)	610A0406	1
RING-O,31.5X2.6 (Ref # 92055)	92055-049	1
RING-O,154MM (Ref # 92055A)	92055-1165	1
RING-O,67.6X3.5 (Ref # 92055B)	92055-1327	1
RING-O,32.7X3.5 (Ref # 92055C)	92055-1556	2
PLUG (Ref # 92066)	92066-1110	1
PLUG,6.2X3 (Ref # 92066A)	92066-1272	1
SPRING,PROPELLER SHAFT (Ref # 92081)	92081-1183	1
SPRING,BOOT (Ref # 92145)	92145-1162	1